



# CATÁLOGO

MADE IN SPAIN

# UBICACIÓN

Situada en Aretxabaleta. Dentro de la comarca guipuzcoana del Alto Deba. Un núcleo industrial referente con una destacada experiencia en innovación de producto y perfectamente comunicada con el resto de la península y Europa.



La concentración en un mismo espacio físico de oficinas comerciales, técnicas, producción y almacenamiento se traduce en mayor coordinación, eficacia y rapidez de respuesta.

# experiencia y futuro

Más de 75 años en el mundo de la cerrajería nos proporcionan un control del medio, de las redes de distribución y de las necesidades del cliente. Pero sobre todo nos ha permitido entender que era el momento de dar un paso hacia adelante.





## ÍNDICE POR REFERENCIA

REF.	PÁG.	REF.	PÁG.	REF.	PÁG.	REF.	PÁG.
3001	158	11A/3P	79	156A70D/1	88	184A38/6AN	25
13718000	165	11B	81	156A70I/0	88	184C23/6	25
13718000	166	11B/M	81	156A70I/1	88	184C23/6AN	25
14154000	165	11E	80	156B60D/0	89	184C25/6	25
14154000	165	122A70D/0	94	156B60D/1	89	184C25/6AN	25
1122A70D/0	94	122A70D/1	94	156B60I/0	89	184C28/6	25
1122A70D/1	94	122A70I/0	94	156B60I/1	89	184C28/6AN	25
1122A70I/0	94	122A70I/1	94	156BR70D/0	89	184C30/6	25
1122A70I/1	94	122C70D/0	95	156BR70D/1	89	184C30/6AN	25
1122C70D/0	95	122C70D/1	95	156BR70I/0	89	184C33/6	25
1122C70D/1	95	122C70I/0	95	156BR70I/1	89	184C33/6AN	25
1122C70I/0	95	122C70I/1	95	156C60D/0	90	184C35/6	25
1122C70I/1	95	123A10D/0	96	156C60D/1	90	184C35/6AN	25
1123A10D/0	96	123A10D/1	96	156C60I/0	90	184C38/6	25
1123A10D/1	96	123A10I/0	96	156C60I/1	90	184C38/6AN	25
1123A10I/0	96	123A10I/1	96	156C70D/0	90	184V23/6	26
1123A10I/1	96	123A12D/0	96	156C70D/1	90	184V23/6AN	26
1123A12D/0	96	123A12D/1	96	156C70I/0	90	184V25/6	26
1123A12D/1	96	123A12I/0	96	156C70I/1	90	184V25/6AN	26
1123A12I/0	96	123A12I/1	96	184/23/0	24	184V28/6	26
1123A12I/1	96	123C10D/0	97	184/23/0AN	24	184V28/6AN	26
1123C10D/0	97	123C10D/1	97	184/23/6	24	184V30/6	26
1123C10D/1	97	123C10I/0	97	184/23/6AN	24	184V30/6AN	26
1123C10I/0	97	123C10I/1	97	184/25/0	24	184V33/6	26
1123C10I/1	97	123C12D/0	97	184/25/0AN	24	184V33/6AN	26
1123C12D/0	97	123C12D/1	97	184/25/6	24	184V35/6	26
1123C12D/1	97	123C12I/0	97	184/25/6AN	24	184V35/6AN	26
1123C12I/0	97	123C12I/1	97	184/28/0	24	184V38/6	26
1123C12I/1	97	124A10D/0	93	184/28/0AN	24	184V38/6AN	26
1124A10D/0	93	124A10D/1	93	184/28/6	24	190/23/0	58
1124A10D/1	93	124A10I/0	93	184/28/6AN	24	190/23/5	58
1124A10I/0	93	124A10I/1	93	184/30/0	24	190/23/6	58
1124A10I/1	93	124A12D/0	93	184/30/0AN	24	190/28/0	58
1124A12D/0	93	124A12D/1	93	184/30/6	24	190/28/5	58
1124A12D/1	93	124A12I/0	93	184/30/6AN	24	190/28/6	58
1124A12I/0	93	124A12I/1	93	184/33/0	24	190/33/0	58
1124A12I/1	93	124A14D/0	93	184/33/0AN	24	190/33/5	58
1124A14D/0	93	124A14D/1	93	184/33/6	24	190/33/6	58
1124A14D/1	93	124A14I/0	93	184/33/6AN	24	190A23/0	58
1124A14I/0	93	124A14I/1	93	184/35/0	24	190A23/5	58
1124A14I/1	93	124A8D/0	93	184/35/0AN	24	190A23/6	58
1124A8D/0	93	124A8D/1	93	184/35/6	24	190A28/0	58
1124A8D/1	93	124A8I/0	93	184/35/6AN	24	190A28/5	58
1124A8I/0	93	124A8I/1	93	184/38/0	24	190A28/6	58
1124A8I/1	93	125A12D/0	91	184/38/0AN	24	190A33/0	58
1125A12D/0	91	125A12D/1	91	184/38/6	24	190A33/5	58
1125A12D/1	91	125A12I/0	91	184/38/6AN	24	190A33/6	58
1125A12I/0	91	125A12I/1	91	184A23/0	25	192/25/6	36
1125A12I/1	91	125A14D/0	91	184A23/0AN	25	192/25/6AN	36
1125A14D/0	91	125A14D/1	91	184A23/6	25	192/30/6	36
1125A14D/1	91	125A14I/0	91	184A23/6AN	25	192/30/6AN	36
1125A14I/0	91	125A14I/1	91	184A25/0	25	192/35/6	36
1125A14I/1	91	125A8D/0	91	184A25/0AN	25	192/35/6AN	36
1125A8D/0	91	125A8D/1	91	184A25/6	25	192V25/6	36
1125A8D/1	91	125A8I/0	91	184A25/6AN	25	192V25/6AN	36
1125A8I/0	91	125A8I/1	91	184A28/0	25	192V30/6	36
1125A8I/1	91	125AR10D/0	91	184A28/0AN	25	192V30/6AN	36
1125AR10D/0	91	125AR10D/1	91	184A28/6	25	192V35/6	36
1125AR10D/1	91	125AR10I/0	91	184A28/6AN	25	192V35/6AN	36
1125AR10I/0	91	125AR10I/1	91	184A30/0	25	194/25/6	38
1125AR10I/1	91	125BR12D/0	92	184A30/0AN	25	194/25/6AN	38
1125BR12D/0	92	125BR12D/1	92	184A30/6	25	194/25/6U	38
1125BR12D/1	92	125BR12I/0	92	184A30/6AN	25	194/30/6	38
1125BR12I/0	92	125BR12I/1	92	184A33/0	25	194/30/6AN	38
1125BR12I/1	92	125BR14D/0	92	184A33/0AN	25	194/30/6U	38
1125BR14D/0	92	125BR14D/1	92	184A33/6	25	194/35/6	38
1125BR14D/1	92	125BR14I/0	92	184A33/6AN	25	194/35/6AN	38
1125BR14I/0	92	125BR14I/1	92	184A35/0	25	194/35/6U	38
1125BR14I/1	92	1404X000-Y	166	184A35/0AN	25	194T25/6	38
11981/60/0	74	156A60D/0	88	184A35/6	25	194T25/6AN	38
11981/60/5	74	156A60D/1	88	184A35/6AN	25	194T25/6U	38
11981V60/0	74	156A60I/0	88	184A38/0	25	194T30/6	38
11981V60/5	74	156A60I/1	88	184A38/0AN	25	194T30/6AN	38
11A	79	156A70D/0	88	184A38/6	25	194T30/6U	38



**ÍNDICE POR REFERENCIA**

REF.	PÁG.	REF.	PÁG.	REF.	PÁG.	REF.	PÁG.
194T35/6	38	1964T/6	73	196V25/6AN	30	1983/20/0	67
194T35/6AN	38	1964V/0	73	196V25/6U	30	1983/20/5	67
194T35/6U	38	1964V/5	73	196V28/6	30	1983/20/6	67
194V25/6	39	1964V/6	73	196V28/6AN	30	1983/25/0	67
194V25/6AN	39	1968/0	76	196V30/6	30	1983/25/5	67
194V25/6U	39	1968/5	76	196V30/6AN	30	1983/25/6	67
194V30/6	39	196A25/6	28	196V30/6U	30	1983/30/0	67
194V30/6AN	39	196A25/6AN	28	196V33/6	30	1983/30/5	67
194V30/6U	39	196A25/6U	28	196V33/6AN	30	1983/30/6	67
194V35/6	39	196A28/6	28	196V35/6	30	1983A20/0	67
194V35/6AN	39	196A28/6AN	28	196V35/6AN	30	1983A20/5	67
194V35/6U	39	196A30/6	28	196V35/6U	30	1983A25/0	67
196/25/6	27	196A30/6AN	28	196V38/6	30	1983A25/5	67
196/25/6AN	27	196A30/6U	28	196V38/6AN	30	1983A30/0	67
196/25/6U	27	196A33/6	28	197/25/6	31	1983A30/5	67
196/28/6	27	196A33/6AN	28	197/28/6	31	1983C20/6	67
196/28/6AN	27	196A35/6	28	197/30/6	31	1983C25/6	67
196/30/6	27	196A35/6AN	28	197/33/6	31	1983C30/6	67
196/30/6AN	27	196A35/6U	28	197/35/6	31	1983R20/0	68
196/30/6U	27	196A38/6	28	197/38/6	31	1983R25/0	68
196/33/6	27	196A38/6AN	28	1970/40/2	109	1983R30/0	68
196/33/6AN	27	196C25/6	28	1970/40/6	109	1983RV/0	68
196/35/6	27	196C25/6AN	28	1970/50/2	109	1983T20/6	68
196/35/6AN	27	196C25/6U	28	1970/50/6	109	1983T25/6	68
196/35/6U	27	196C28/6	28	1970/60/2	109	1983T30/6	68
196/38/6	27	196C28/6AN	28	1970/60/6	109	1984/20/0	54
196/38/6AN	27	196C30/6	28	1970A40/2	109	1984/20/5	54
1960/60/2	111	196C30/6AN	28	1970A40/6	109	1984/20/6	54
1960/60/6	111	196C30/6U	28	1970A50/2	109	1984/25/0	54
1960/70/2	111	196C33/6	28	1970A50/6	109	1984/25/5	54
1960/70/6	111	196C33/6AN	28	1970A60/2	109	1984/25/6	54
1960A60/2	111	196C35/6	28	1970A60/6	109	1984/30/0	54
1960A60/6	111	196C35/6AN	28	1970T40/2	109	1984/30/5	54
1960A70/2	111	196C35/6U	28	1970T40/6	109	1984/30/6	54
1960A70/6	111	196C38/6	28	1970T50/2	109	1984C20/6	54
1960T60/2	111	196C38/6AN	28	1970T50/6	109	1984C25/6	54
1960T60/6	111	196R23/6	29	1970T60/2	109	1984C30/6	54
1960T70/2	111	196R23/6AN	29	1970T60/6	109	1984T20/6	55
1960T70/6	111	196R25/6	29	1970V40/2	110	1984T25/6	55
1961/60/2	112	196R25/6AN	29	1970V40/6	110	1984T30/6	55
1961/70/2	112	196R25/6U	29	1970V50/2	110	1984V20/6	55
1961A60/2	112	196R28/6	29	1970V50/6	110	1984V25/6	55
1961A70/2	112	196R28/6AN	29	1970V60/2	110	1984V30/6	55
1962/60/2	113	196R30/6	29	1970V60/6	110	1985/3P/2	108
1962/70/2	113	196R30/6AN	29	1975/0	71	1985/40/2	108
1962A60/2	113	196R30/6U	29	1975/5	71	1985/40/6	108
1962A70/2	113	196R33/6	29	1975A/0	71	1985/50/2	108
1962T60/2	113	196R33/6AN	29	1975A/5	71	1985/50/6	108
1962T70/2	113	196R35/6	29	1975T/0	71	1985/60/2	108
1963/0	69	196R35/6AN	29	1975T/5	71	1985/60/6	108
1963/5	69	196R35/6U	29	1975V/0	71	1985T40/2	108
1963/6	69	196R38/6	29	1975V/5	71	1985T40/6	108
1963A/0	69	196R38/6AN	29	1976/1	98	1985T50/2	108
1963A/5	69	196RV/6	30	1978/0	99	1985T50/6	108
1963A/6	69	196RV/6AN	30	1978/1	99	1985T60/2	108
1963C/6	69	196RV/6U	30	1979/0	78	1985T60/6	108
1963CP16/6	70	196T23/6	29	1979/5	78	1988/0	100
1963R/0	70	196T23/6AN	29	1979P/0	78	1988/1	100
1963RV/0	70	196T25/6	29	1979P/5	78	1990/20/0	59
1963V/0	70	196T25/6AN	29	197K25/6	31	1990/20/5	59
1963V/5	70	196T25/6U	29	197K28/6	31	1990/20/6	59
1963V/6	70	196T28/6	29	197K30/6	31	1990/25/0	59
1964/0	72	196T28/6AN	29	197K33/6	31	1990/25/5	59
1964/5	72	196T30/6	29	197K35/6	31	1990/25/6	59
1964/6	72	196T30/6AN	29	197K38/6	31	1990/32/0	59
1964A/0	72	196T30/6U	29	197KB25/6	31	1990/32/5	59
1964A/5	72	196T33/6	29	197KB30/6	31	1990/32/6	59
1964C/0	72	196T33/6AN	29	197KB35/6	31	1990A20/0	59
1964C/6	72	196T35/6	29	1981/60/0	74	1990A20/5	59
1964CP/6	72	196T35/6AN	29	1981/60/5	74	1990A20/6	59
1964R/0	73	196T35/6U	29	1981V60/0	74	1990A25/0	59
1964RV/0	73	196T38/6	29	1981V60/5	74	1990A25/5	59
1964T/0	73	196T38/6AN	29	1982/0	77	1990A25/6	59
1964T/5	73	196V25/6	30	1982/5	77	1990A32/0	59

## ÍNDICE POR REFERENCIA

REF.	PÁG.	REF.	PÁG.	REF.	PÁG.	REF.	PÁG.
1990A32/5	59	1K2/30/6AN	19	294V25/6U	41	2E2/35/6L	15
1990A32/6	59	1K2/30/6U	19	294V30/6L	41	2E2/35/6LAN	15
1990V20/0	59	1K2/33/6	19	294V30/6LAN	41	2E2/35/6U	15
1990V20/5	59	1K2/33/6AN	19	294V30/6U	41	2E2/40/6L	15
1990V20/6	59	1K2/35/6	19	294V35/6L	41	2E2/40/6LAN	15
1990V25/0	59	1K2/35/6AN	19	294V35/6LAN	41	2E2/40/6U	15
1990V25/5	59	1K2/35/6U	19	294V35/6U	41	2E2/50/6L	15
1990V25/6	59	1K2T/30/6	20	296/25/6L	32	2E2/50/6LAN	15
1990V32/0	59	1K2T/30/6AN	20	296/25/6LAN	32	2E2/50/6U	15
1990V32/5	59	1K2T/30/6U	20	296/25/6U	32	2E5/30/6L	13
1990V32/6	59	1K2T/33/6	20	296/28/6L	32	2E5/30/6LAN	13
1991/60/0	75	1K2T/33/6AN	20	296/28/6LAN	32	2E5/30/6U	13
1991/60/5	75	1K2T/35/6	20	296/30/6L	32	2E5/35/6L	13
1991/70/0	75	1K2T/35/6AN	20	296/30/6LAN	32	2E5/35/6LAN	13
1991/70/5	75	1K2T/35/6U	20	296/30/6U	32	2E5/35/6U	13
1992/20/6	66	1K5/30/6	16	296/33/6L	32	2E5/40/6L	13
1992/25/6	66	1K5/30/6AN	16	296/33/6LAN	32	2E5/40/6LAN	13
1992/30/6	66	1K5/30/6U	16	296/35/6L	32	2E5/40/6U	13
1992C20/6	66	1K5/33/6	16	296/35/6LAN	32	2E5/50/6L	13
1992C25/6	66	1K5/33/6AN	16	296/35/6U	32	2E5/50/6LAN	13
1992C30/6	66	1K5/35/6	16	296/38/6L	32	2E5/50/6U	13
1992T20/6	66	1K5/35/6AN	16	296/38/6LAN	32	2K2/30/6L	21
1992T25/6	66	1K5/35/6U	16	296A25/6L	33	2K2/30/6LAN	21
1992T30/6	66	1K5T/30/6	17	296A25/6LAN	33	2K2/30/6U	21
1994/25/6	60	1K5T/30/6AN	17	296A25/6U	33	2K2/33/6L	21
1994/25/6L	60	1K5T/30/6U	17	296A28/6L	33	2K2/33/6LAN	21
1994/30/6	60	1K5T/33/6	17	296A28/6LAN	33	2K2/35/6L	21
1994/30/6L	60	1K5T/33/6AN	17	296A30/6L	33	2K2/35/6LAN	21
1994/35/6	60	1K5T/35/6	17	296A30/6LAN	33	2K2/35/6U	21
1994/35/6L	60	1K5T/35/6AN	17	296A30/6U	33	2K5/30/6L	18
1994A25/6	61	1K5T/35/6U	17	296A33/6L	33	2K5/30/6LAN	18
1994A25/6L	61	202/30/6L	22	296A33/6LAN	33	2K5/30/6U	18
1994A30/6	61	202/30/6LAN	22	296A35/6L	33	2K5/33/6L	18
1994A30/6L	61	202/30/6U	22	296A35/6LAN	33	2K5/33/6LAN	18
1994A35/6	61	202/33/6L	22	296A35/6U	33	2K5/35/6L	18
1994A35/6L	61	202/33/6LAN	22	296A38/6L	33	2K5/35/6LAN	18
1994V25/6	61	202/33/6U	22	296A38/6LAN	33	2K5/35/6U	18
1994V25/6L	61	202/35/6L	22	296V25/6L	33	3000AD	158
1994V30/6	61	202/35/6LAN	22	296V25/6LAN	33	3000AI	158
1994V30/6L	61	202/35/6U	22	296V25/6U	33	3000D	157
1994V35/6	61	234/50/1	101	296V28/6L	33	3000I	157
1994V35/6L	61	234/60/1	101	296V28/6LAN	33	3005/6	157
1995/32/0	56	234/70/1	101	296V30/6L	33	302/30/6L	23
1995/32/5	56	236/50/1	102	296V30/6LAN	33	302/30/6LAN	23
1995/32/6	56	236/60/1	102	296V30/6U	33	302/30/6U	23
1995A32/6	56	236/70/1	102	296V33/6L	33	302/33/6L	23
1995R32/0	56	249B50/2	117	296V33/6LAN	33	302/33/6LAN	23
1995T32/6	57	249B60/2	117	296V35/6L	33	302/33/6U	23
1995V32/6	57	249C50/2	117	296V35/6LAN	33	302/35/6L	23
1E2/30/6	14	249C60/2	117	296V35/6U	33	302/35/6LAN	23
1E2/30/6AN	14	249C70/2	117	296V38/6L	33	302/35/6U	23
1E2/30/6U	14	249R50/2	117	296V38/6LAN	33	396/25/6L	34
1E2/35/6	14	249R60/2	117	297K25/6U16	35	396/28/6L	34
1E2/35/6AN	14	249R70/2	117	2994/25/6	62	396/30/6L	34
1E2/35/6U	14	294/25/6L	40	2994/25/6L	62	396/33/6L	34
1E2/40/6	14	294/25/6LAN	40	2994/30/6	62	396/35/6L	34
1E2/40/6AN	14	294/25/6U	40	2994/30/6L	62	396/38/6L	34
1E2/40/6U	14	294/30/6L	40	2994/35/6	62	3994/25/6	64
1E2/50/6	14	294/30/6LAN	40	2994/35/6L	62	3994/25/6L	64
1E2/50/6AN	14	294/30/6U	40	2994A25/6	63	3994/30/6	64
1E2/50/6U	14	294/35/6L	40	2994A25/6L	63	3994/30/6L	64
1E5/30/6	12	294/35/6LAN	40	2994A30/6	63	3994/35/6	64
1E5/30/6AN	12	294/35/6U	40	2994A30/6L	63	3994/35/6L	64
1E5/30/6U	12	294A25/6L	41	2994A35/6	63	3994A25/6	64
1E5/35/6	12	294A25/6U	41	2994A35/6L	63	3994A25/6L	64
1E5/35/6AN	12	294A25/L6AN	41	2994V25/6	63	3994A30/6	64
1E5/35/6U	12	294A30/6L	41	2994V25/6L	63	3994A30/6L	64
1E5/40/6	12	294A30/6U	41	2994V30/6	63	3994A35/6	64
1E5/40/6AN	12	294A30/L6AN	41	2994V30/6L	63	3994A35/6L	64
1E5/40/6U	12	294A35/6L	41	2994V35/6	63	3994F25/6	65
1E5/50/6	12	294A35/6U	41	2994V35/6L	63	3994F25/6L	65
1E5/50/6AN	12	294A35/L6AN	41	2E2/30/6L	15	3994F30/6	65
1E5/50/6U	12	294V25/6L	41	2E2/30/6LAN	15	3994F30/6L	65
1K2/30/6	19	294V25/6LAN	41	2E2/30/6U	15	3994F35/6	65

**ÍNDICE POR REFERENCIA**

REF.	PÁG.	REF.	PÁG.	REF.	PÁG.	REF.	PÁG.
3994F35/6L	65	56C60D/1	90	5982/2560/3	122	5982P2540/3	124
3994V25/6	65	56C60I/0	90	5982/2560/4	122	5982P2540/4	124
3994V25/6L	65	56C60I/1	90	5982/2565/3	122	5982P2545/3	124
3994V30/6	65	56C70D/0	90	5982/2565/4	122	5982P2545/4	124
3994V30/6L	65	56C70D/1	90	5982/2575/3	123	5982P2550/3	124
3994V35/6	65	56C70I/0	90	5982/2575/4	123	5982P2550/4	124
3994V35/6L	65	56C70I/1	90	5982/2585/3	123	5982P2555/3	124
400/50/6HP	152	5961/2525/3	138	5982/2585/4	123	5982P2555/4	124
400/60/6HP	152	5961/2525/4	138	5982/2595/3	123	5982P2560/3	124
4000/50/0	106	5961/3030/3	138	5982/2595/4	123	5982P2560/4	124
4000/60/0	106	5961/3030/4	138	5982/3030/3	122	5982P2565/3	124
4000A50/0	106	5962/2525/3	139	5982/3030/4	122	5982P2565/4	124
4000A60/0	106	5962/3030/3	139	5982/3035/3	122	5982P25725/3	125
4001/50/0	106	5962/4040/3	139	5982/3035/4	122	5982P25725/4	125
4001/60/0	106	5962T30/3	139	5982/3040/3	122	5982P3030/3	124
4001A50/0	106	5962T40/3	139	5982/3040/4	122	5982P3030/4	124
4001A60/0	106	5963/2222/3	136	5982/3045/3	122	5982P3045/3	124
400L60/6HP	152	5963/2222/4	136	5982/3045/4	122	5982P3045/4	124
400LT60/6H	153	5963/2525/3	136	5982/3050/3	122	5982P30730/3	125
400T50/6H	153	5963/2525/4	136	5982/3050/4	122	5982P30730/4	125
400T60/6H	153	5963/3030/3	136	5982/3055/3	122	5982P30745/3	125
401/50/6HP	152	5963/3030/4	136	5982/3055/4	122	5982P30745/4	125
401/60/6HP	152	5963/3535/3	136	5982/3060/3	122	5982P3525/3	124
401L60/6HP	152	5963/3535/4	136	5982/3060/4	122	5982P3525/4	124
401LT60/6H	153	5963/4040/3	136	5982/3080/3	123	5982P3535/3	124
401T50/6H	153	5963/4040/4	136	5982/3080/4	123	5982P3535/4	124
401T60/6H	153	5963T36/3	136	5982/3535/3	122	5982P3540/3	124
410/50/6HP	156	5963T36/4	136	5982/3535/4	122	5982P3540/4	124
410/50D/6HP	155	5964/2525/3	140	5982/3540/3	122	5982P3545/3	124
410/50I/6HP	155	5964/2525/4	140	5982/3540/4	122	5982P3545/4	124
410/60/6HP	156	5964/3030/3	140	5982/3545/3	122	5982P35725/3	125
410/60D/6HP	155	5964/3030/4	140	5982/3545/4	122	5982P35725/4	125
410/60I/6HP	155	5964/4040/3	140	5982/3555/3	122	5982P35735/3	125
4100/50/0	107	5964/4040/4	140	5982/3555/4	122	5982P35735/4	125
4100/60/0	107	5964P3030/3	140	5982/3565/3	123	5982PT2505/3	124
410L60/6HP	155	5964P3030/4	140	5982/3565/4	123	5982PT2505/4	124
410L60D/6HP	154	5964T25/3	140	5982/3575/3	123	5982PT2525/3	125
410L60I/6HP	154	5964T25/4	140	5982/3575/4	123	5982PT2525/4	125
411/50/6HP	156	5964T30/3	140	5982/3595/3	123	5982PT2535/3	125
411/50D/6HP	155	5964T30/4	140	5982/3595/4	123	5982PT2535/4	125
411/50I/6HP	155	5964T40/3	140	5982/4040/3	122	5982PT2545/3	125
411/60/6HP	156	5964T40/4	140	5982/4040/4	122	5982PT2545/4	125
411/60D/6HP	155	5968/2525/3	141	5982/4050/3	123	5982T40/3	124
411/60I/6HP	155	5968/2525/4	141	5982/4050/4	123	5982T40/4	124
411L60/6HP	155	5968/3030/3	141	5982/4055/3	123	5982T45/3	124
411L60D/6HP	154	5968/3030/4	141	5982/4055/4	123	5982T45/4	124
411L60I/6HP	154	5968/4040/3	141	5982/4060/3	123	5982T50/3	124
5000/1N	145	5968/4040/4	141	5982/4060/4	123	5982T50/4	124
5000/1NM	145	5968P3030/3	141	5982/4070/3	123	5982T55/3	124
5000/6	145	5968P3030/4	141	5982/4070/4	123	5982T55/4	124
5081/3030/3	137	5968T25/3	141	5982/4080/3	123	5982T60/3	124
5081/3030/4	137	5968T25/4	141	5982/4080/4	123	5982T60/4	124
5181/3030/3	137	5968T30/3	141	5982/4545/3	123	5982T65/3	124
5181/3030/4	137	5968T30/4	141	5982/4545/4	123	5982T65/4	124
5500/1N	146	5968T40/3	141	5982/4555/3	123	5982T70/3	124
5500/1NM	146	5968T40/4	141	5982/4555/4	123	5982T70/4	124
5500/6	146	5979/3030/3	142	5982/5050/3	123	5990/2525/3	126
56A60D/0	88	5979/3030/4	142	5982/5050/4	123	5990/2525/4	126
56A60D/1	88	5979P3030/3	142	5982/5555/3	123	5990/2530/3	126
56A60I/0	88	5979P3030/4	142	5982/5555/4	123	5990/2530/4	126
56A60I/1	88	5982/2525/3	122	5982/6060/3	123	5990/2535/3	126
56A70D/0	88	5982/2525/4	122	5982/6060/4	123	5990/2535/4	126
56A70D/1	88	5982/2530/3	122	5982/6565/3	123	5990/2540/3	126
56A70I/0	88	5982/2530/4	122	5982/6565/4	123	5990/2540/4	126
56A70I/1	88	5982/2535/3	122	5982/7070/3	123	5990/2545/3	126
56B60D/0	89	5982/2535/4	122	5982/7070/4	123	5990/2545/4	126
56B60D/1	89	5982/2540/3	122	5982/7575/3	123	5990/2550/3	126
56B60I/0	89	5982/2540/4	122	5982/7575/4	123	5990/2550/4	126
56B60I/1	89	5982/2545/3	122	5982P2525/3	124	5990/2555/3	126
56BR70D/0	89	5982/2545/4	122	5982P2525/4	124	5990/2555/4	126
56BR70D/1	89	5982/2550/3	122	5982P2530/3	124	5990/2560/3	126
56BR70I/0	89	5982/2550/4	122	5982P2530/4	124	5990/2560/4	126
56BR70I/1	89	5982/2555/3	122	5982P2535/3	124	5990/2565/3	126
56C60D/0	90	5982/2555/4	122	5982P2535/4	124	5990/2565/4	126



## ÍNDICE POR REFERENCIA

REF.	PÁG.	REF.	PÁG.	REF.	PÁG.	REF.	PÁG.
5990/2575/3	127	5990P2550/3	128	615/35/6	148	6982/4050/4	131
5990/2575/4	127	5990P2550/4	128	615/35/6AN	148	6982/4055/3	131
5990/2585/3	127	5990P2555/3	128	615E/25/6	149	6982/4055/4	131
5990/2585/4	127	5990P2555/4	128	615E/25/6AN	149	6982/4545/3	131
5990/2595/3	127	5990P2560/3	128	615E/30/6	149	6982/4545/4	131
5990/2595/4	127	5990P2560/4	128	615E/30/6AN	149	6982/4555/3	131
5990/3030/3	126	5990P2565/3	128	615E/35/6	149	6982/4555/4	131
5990/3030/4	126	5990P2565/4	128	615E/35/6AN	149	6982/4560/3	131
5990/3035/3	126	5990P25T25/3	129	62/50/2	114	6982/4560/4	131
5990/3035/4	126	5990P25T25/4	129	62/60/2	114	6982/5050/3	131
5990/3040/3	126	5990P3030/3	128	63R50/2	114	6982/5050/4	131
5990/3040/4	126	5990P3030/4	128	63R60/2	114	6982/5555/3	131
5990/3045/3	126	5990P3045/3	128	63R70/2	114	6982/5555/4	131
5990/3045/4	126	5990P3045/4	128	6964/3030/3	140	6982/6565/3	131
5990/3050/3	126	5990P30T30/3	129	6964/3030/4	140	6982/6565/4	131
5990/3050/4	126	5990P30T30/4	129	6964T30/3	140	6982/7070/3	131
5990/3055/3	126	5990P30T45/3	129	6964T30/4	140	6982/7070/4	131
5990/3055/4	126	5990P30T45/4	129	6968/3030/3	141	6982/7575/3	131
5990/3060/3	127	5990P3525/3	128	6968/3030/4	141	6982/7575/4	131
5990/3060/4	127	5990P3525/4	128	6968T30/3	141	6982P2525/3	132
5990/3080/3	127	5990P3535/3	128	6968T30/4	141	6982P2525/4	132
5990/3080/4	127	5990P3535/4	128	6982/2525/3	130	6982P2535/3	132
5990/3535/3	126	5990P3540/3	128	6982/2525/4	130	6982P2535/4	132
5990/3535/4	126	5990P3540/4	128	6982/2530/3	130	6982P2545/3	132
5990/3540/3	126	5990P3545/3	128	6982/2530/4	130	6982P2545/4	132
5990/3540/4	126	5990P3545/4	128	6982/2535/3	130	6982P2555/3	132
5990/3545/3	126	5990P35T25/3	129	6982/2535/4	130	6982P2555/4	132
5990/3545/4	126	5990P35T25/4	129	6982/2540/3	130	6982P3030/3	132
5990/3555/3	127	5990P35T35/3	129	6982/2540/4	130	6982P3030/4	132
5990/3555/4	127	5990P35T35/4	129	6982/2545/3	130	6982P3525/3	132
5990/3565/3	127	5990PT2505/3	128	6982/2545/4	130	6982P3525/4	132
5990/3565/4	127	5990PT2505/4	128	6982/2550/3	130	6982P3535/3	132
5990/3575/3	127	5990PT2525/3	129	6982/2550/4	130	6982P3535/4	132
5990/3575/4	127	5990PT2525/4	129	6982/2555/3	130	6982P3545/3	132
5990/3595/3	127	5990PT2535/3	129	6982/2555/4	130	6982P3545/4	132
5990/3595/4	127	5990PT2535/4	129	6982/2560/3	130	6982P3555/3	132
5990/4040/3	126	5990PT2545/3	129	6982/2560/4	130	6982P3555/4	132
5990/4040/4	126	5990PT2545/4	129	6982/2565/3	131	6982P3565/3	132
5990/4050/3	127	5990T40/3	128	6982/2565/4	131	6982P3565/4	132
5990/4050/4	127	5990T40/4	128	6982/2575/3	131	6982T40/3	132
5990/4055/3	127	5990T45/3	128	6982/2575/4	131	6982T40/4	132
5990/4055/4	127	5990T45/4	128	6982/2585/3	131	6982T50/3	132
5990/4060/3	127	5990T50/3	128	6982/2585/4	131	6982T50/4	132
5990/4060/4	127	5990T50/4	128	6982/2595/3	131	6982T60/3	132
5990/4070/3	127	5990T55/3	128	6982/2595/4	131	6982T60/4	132
5990/4070/4	127	5990T55/4	128	6982/3030/3	130	6982T70/3	132
5990/4080/3	127	5990T60/3	128	6982/3030/4	130	6982T70/4	132
5990/4080/4	127	5990T60/4	128	6982/3035/3	130	6990/2525/3	133
5990/4545/3	127	5990T65/3	128	6982/3035/4	130	6990/2525/4	133
5990/4545/4	127	5990T65/4	128	6982/3040/3	130	6990/2530/3	133
5990/4555/3	127	5990T70/3	128	6982/3040/4	130	6990/2530/4	133
5990/4555/4	127	5990T70/4	128	6982/3045/3	130	6990/2535/3	133
5990/5050/3	127	6000D/1N	147	6982/3045/4	130	6990/2535/4	133
5990/5050/4	127	6000D/1NM	147	6982/3050/3	130	6990/2540/3	133
5990/5555/3	127	6000D/6	147	6982/3050/4	130	6990/2540/4	133
5990/5555/4	127	6000I/1N	147	6982/3055/3	130	6990/2545/3	133
5990/6060/3	127	6000I/1NM	147	6982/3055/4	130	6990/2545/4	133
5990/6060/4	127	6000I/6	147	6982/3060/3	131	6990/2550/3	133
5990/6565/3	127	612/25/6	150	6982/3060/4	131	6990/2550/4	133
5990/6565/4	127	612/25/6AN	150	6982/3535/3	130	6990/2555/3	133
5990/7070/3	127	612/30/6	150	6982/3535/4	130	6990/2555/4	133
5990/7070/4	127	612/30/6AN	150	6982/3540/3	130	6990/2560/3	133
5990/7575/3	127	612/35/6	150	6982/3540/4	130	6990/2560/4	133
5990/7575/4	127	612/35/6AN	150	6982/3545/3	130	6990/2565/3	134
5990P2525/3	128	612E/25/6	151	6982/3545/4	130	6990/2565/4	134
5990P2525/4	128	612E/25/6AN	151	6982/3555/3	131	6990/2575/3	134
5990P2530/3	128	612E/30/6	151	6982/3555/4	131	6990/2575/4	134
5990P2530/4	128	612E/30/6AN	151	6982/3565/3	131	6990/2585/3	134
5990P2535/3	128	612E/35/6	151	6982/3565/4	131	6990/2585/4	134
5990P2535/4	128	612E/35/6AN	151	6982/4040/3	130	6990/2595/3	134
5990P2540/3	128	615/25/6	148	6982/4040/4	130	6990/2595/4	134
5990P2540/4	128	615/25/6AN	148	6982/4045/3	130	6990/3030/3	133
5990P2545/3	128	615/30/6	148	6982/4045/4	130	6990/3030/4	133
5990P2545/4	128	615/30/6AN	148	6982/4050/3	131	6990/3035/3	133

**ÍNDICE POR REFERENCIA**

REF.	PÁG.	REF.	PÁG.	REF.	PÁG.	REF.	PÁG.
6990/3035/4	133	942R/R/2	116	CE202S/1NR	47	KCE1K5/1NRS	46
6990/3040/3	133	942RC/C/2	116	CE202S/1NRS	47	KCE1K5/6L	46
6990/3040/4	133	942RC/R/2	116	CE202S/6L	47	KCE1K5/6LR	46
6990/3045/3	133	943/2C	115	CE202S/6LAN	47	KES4000	120
6990/3045/4	133	943/2R	115	CE202S/6LR18	48	KES4100	120
6990/3050/3	133	943/7C	115	CE202S/6LR20	48	M5000/1N	161
6990/3050/4	133	943/7R	115	CE202S/6U	48	M5001/1N	161
6990/3055/3	133	943P/2C	115	CE249R/2	119	M5002/1N	161
6990/3055/4	133	943P/2R	115	CE249R/6	119	M5003/1N	161
6990/3060/3	134	943P/7C	115	CE296S/1NR	45	M5004/1N	161
6990/3060/4	134	943P/7R	115	CE296S/1NRS	45	P192/25/6	36
6990/3535/3	133	B5000	162	CE296S/6L	44	P192/30/6	36
6990/3535/4	133	B5000/4	162	CE296S/6LAN	44	P192/35/6	36
6990/3540/3	133	BAR5000/1R	162	CE296S/6LR	44	P192V25/6	36
6990/3540/4	133	BAR5000/1RE	162	CE296S/6RU	45	P192V30/6	36
6990/3545/3	133	BAR5000/6	162	CE296S/6U	44	P192V35/6	36
6990/3545/4	133	BAR5000/6E	162	CE2994S/6	84	P1E2/30/6	14
6990/3555/3	134	BT1296/1N	51	CE4000/2	118	P1E2/35/6	14
6990/3555/4	134	BT1296/1NM	51	CE4000/6	118	P1E2/40/6	14
6990/3565/3	134	BT1296/1PL	51	CE4001/2	118	P1E2/50/6	14
6990/3565/4	134	BT194/1N	51	CE4001/6	118	P1E5/30/6	12
6990/4040/3	133	BT194/1N	86	CE5000/1N	162	P1E5/35/6	12
6990/4040/4	133	BT194/1NM	51	CE5000/6	162	P1E5/40/6	12
6990/4045/3	133	BT194/1NM	86	CE942C30/2	120	P1E5/50/6	12
6990/4045/4	133	BT194/1PL	51	CE942C35/2	120	P1K2/30/6	19
6990/4050/3	134	BT194/1PL	86	CE942R25/2	119	P1K2/35/6	19
6990/4050/4	134	CE184/OL	42	CE942R30/2	119	P1K2T/30/6	20
6990/4055/3	134	CE184/OLAN	42	CE942R30/7	119	P1K2T/35/6	20
6990/4055/4	134	CE184/1N	42	CE942R35/2	119	P1K5/30/6	16
6990/4545/3	134	CE184/1NR	42	CE942R35/7	119	P1K5/35/6	16
6990/4545/4	134	CE184/1NRS	42	CEB6000	162	P1K5T/30/6	17
6990/4555/3	134	CE184/6L	42	CEB6000/1N	162	P1K5T/35/6	17
6990/4555/4	134	CE184/6LAN	42	CEC41/6A	49	P202/30/6	22
6990/4560/3	134	CE184/6U	42	CEC41/6AD	49	P202/33/6	22
6990/4560/4	134	CE184A/OL	42	CEC41T/6A	49	P202/35/6	22
6990/5050/3	134	CE184A/6L	42	CEC41T/6AD	49	P2E2/30/6	15
6990/5050/4	134	CE190/0	82	CELC125/1A	103	P2E2/35/6	15
6990/5555/3	134	CE190/6	82	CELC125/1BA	103	P2E2/40/6	15
6990/5555/4	134	CE196/1N	43	CELC45/6A	85	P2E2/50/6	15
6990/6565/3	134	CE196/1NR	44	CELC45/6AD	85	P2E5/30/6	13
6990/6565/4	134	CE196/1NRS	44	CELC45T/6A	85	P2E5/35/6	13
6990/7070/3	134	CE196/6L	43	CELC45T/6AD	85	P2E5/40/6	13
6990/7070/4	134	CE196/6LAN	43	CELC56/1A	103	P2E5/50/6	13
6990/7575/3	134	CE196/6LR	43	CELC56/1BA	103	P2K2/30/6	21
6990/7575/4	134	CE196/6RU	43	CM5006/55/6R	160	P2K2/35/6	21
6990P2525/3	135	CE196/6U	43	CM5006/72/6R	160	P2K5/30/6	18
6990P2525/4	135	CE1960/2	119	CM5006/85/6R	160	P2K5/35/6	18
6990P2535/3	135	CE1960/6	119	CM5007/6R	160	P302/30/6	23
6990P2535/4	135	CE1960A/2	119	CV1E5	51	P302/33/6	23
6990P2545/3	135	CE1960A/6	119	EMB196	51	P302/35/6	23
6990P2545/4	135	CE196R/6	84	ES1960	120	P612/25/6	150
6990P2555/3	135	CE196R/6L	45	ES1960/4	120	P612/30/6	150
6990P2555/4	135	CE196R/6LAN	45	ES1962	120	P612/35/6	150
6990P3030/3	135	CE196R/6LR	45	ES1962/4	120	P612E/25/6	151
6990P3030/4	135	CE1970R/2	119	ES1963	86	P612E/30/6	151
6990P3525/3	135	CE1970R/6	119	ES1964	86	P612E/35/6	151
6990P3525/4	135	CE1983/0	82	ES1964	120	P615/25/6	148
6990P3535/3	135	CE1983/6	82	ES1984	51	P615/30/6	148
6990P3535/4	135	CE1984/0	82	ES1984	86	P615/35/6	148
6990P3545/3	135	CE1984/6	82	F192/25/6	37	P615E/25/6	149
6990P3545/4	135	CE1985/2	118	F192/25/6AN	37	P615E/30/6	149
6990P3555/3	135	CE1985/6	118	F192/30/6	37	P615E/35/6	149
6990P3555/4	135	CE1990/0	83	F192/30/6AN	37	POLCE-CVL	51
6990P3565/3	135	CE1991/0	83	F192/35/6	37	TAP1E5	51
6990P3565/4	135	CE1994/6	83	F192/35/6AN	37	TUF6000/1N	162
6990T40/3	135	CE1E5/6L	46	FP192/25/6	37	TUF6000/1NE	162
6990T40/4	135	CE1E5/6LR	46	FP192/30/6	37	TUF6000/6	162
6990T50/3	135	CE202/1NR	47	FP192/35/6	37	TUF6000/6E	162
6990T50/4	135	CE202/1NRS	47	ID1/60/6R	164	VENM1	159
6990T60/3	135	CE202/6L	47	JES6000/6R	50	VENM2	159
6990T60/4	135	CE202/6LAN	47	JM6000/6R	50	VENM3	159
6990T70/3	135	CE202/6LR18	48	JM6006/85/6R	50	VENM554	159
6990T70/4	135	CE202/6LR20	48	JT6006/85/6R	50		
942R/C/2	116	CE202/6U	48	KCE1K5/1NR	46		

**ABREVIATURAS DE ACABADOS CERRADURAS Y CILINDROS**













<b>COD.</b>	<b>FRENTE</b>	<b>CILINDRO</b>
/0	Hierro Niquelado ( <b>HN</b> )	Latón Niquelado ( <b>CN</b> )
/1	Hierro Esmaltado ( <b>HE</b> )	Latón Pulido ( <b>LP</b> )
/2	Hierro Latonado ( <b>HL</b> )	Latón Pulido ( <b>LP</b> )
/3	Latón Pulido ( <b>LP</b> )	Latón Pulido ( <b>LP</b> )
/4	Latón Niquelado ( <b>LN</b> )	Latón Niquelado ( <b>CN</b> )
/5	Hierro Niquelado ( <b>HN</b> )	Latón Pulido ( <b>LP</b> )
/6	Acero Inoxidable ( <b>AI</b> )	Latón Niquelado ( <b>CN</b> )
/7	Níquel Satinado ( <b>NS</b> )	Latón Niquelado ( <b>CN</b> )
/8	Zincado Trivalente ( <b>Z</b> )	Latón Niquelado ( <b>CN</b> )

**ABREVIATURAS DE ACABADOS DE ANTIPÁNICOS Y ESCUDOS**

<b>COD.</b>	<b>ACABADO</b>
/0	Niquelado
/1AB	Pintado bronce antiguo
/1D	Pintado dorado
/1N	Pintado negro
/1NM	Pintado níquel mate
/1PL	Pintado plata
/2	Latonado
/7	Níquel mate



## CERRADURAS PARA CARPINTERÍA DE ALUMINIO

	Certificado de Ensayo	10
	Palanca deslizante entre ejes 85 mm	12
	• Serie 1E5 <b>Soft</b>	12
	Multipunto palanca deslizante entre ejes 85 mm	13
	• Serie 2E5 <b>Soft</b>	13
	Palanca deslizante entre ejes 92 mm	14
	• Serie 1E2 <b>Soft</b>	14
	Multipunto palanca deslizante entre ejes 92 mm	15
	• Serie 2E2 <b>Soft</b>	15
	Palanca basculante entre ejes 85 mm	16
	• Serie 1K5 <b>DUE</b>	16
	Multipunto palanca basculante entre ejes 85 mm	18
	• Serie 2K5 <b>DUE</b>	18
	Palanca basculante entre ejes 92 mm	19
	• Serie 1K2 <b>DUE</b>	19
	Multipunto palanca basculante entre ejes 92 mm	21
	• Serie 2K2 <b>DUE</b>	21
	Multipunto palanca deslizante entre ejes 92 mm	22
	• Serie 202 <b>inverse</b>	22
	• Serie 302 <b>inverse</b>	23
	Palanca deslizante entre ejes 85 mm	24
	• Serie 184	24
	Palanca basculante entre ejes 85 mm	27
	• Serie 196	27
	Palanca gancho entre ejes 85 mm	31
	• Serie 197	31
	Multipunto palanca basculante entre ejes 85 mm	32
	• Serie 296	32
	Multipunto palanca basculante entre ejes 85 mm	34
	• Serie 396	34
	Multipunto palanca gancho entre ejes 85 mm	35
	• Serie 297K	35
	Palanca deslizante entre ejes 92 mm	36
	• Serie 192	36
	Cerradura cortafuego palanca deslizante entre ejes 92 mm	37
	• Serie F192	37
	Palanca basculante entre ejes 92 mm	38
	• Serie 194	38
	Multipunto frente especial palanca basculante entre ejes 92 mm	40
	• Serie 294	40
	Accesorios	42
	• Cerraderos	42
	• Cerraderos eléctricos	49
	• Escudos y manillas de acero inoxidable	50
	• Escudos	51
	• Otros	51



**CIDEMCO**  
CENTRO DE INVESTIGACION TECNOLÓGICA

Pol. Ind. Lasao, Area Anardi, nº 5  
20730 AZPEITIA (Guipúzcoa)  
Tel.: 943 816800 – Fax: 943 816074  
Email: cidemco@cidemco.es  
http://www.cidemco.es

# Certificado de Ensayos

**EMPRESA** SISTEMAS VALLE LENIZ, S.A.

**DIRECCIÓN** Pol.Ind.Arbi-Zelai s/n  
20550 ARETXABALETA (GIPUZKOA)

**Nº CERTIFICADO** 18146 (1/2)

## MATERIAL ENSAYADO

Cerradura de embutir con palanca deslizante de referencia:

«192/35/6»

- Entrada: 35
- Distancia entre ejes: 92

## ENSAYOS REALIZADOS

**Ensayos mecánicos** establecidos en la norma UNE-EN 12209:2004  
«Herrajes en la edificación. Cerraduras, pestillos y cerraderos mecánicos.  
Requisitos y métodos de ensayo»

## CLASIFICACIÓN

1	C	5	0	0	C	1	B	A	2	0
---	---	---	---	---	---	---	---	---	---	---

**FECHA** 18 de julio de 2008

Este documento no tiene validez sin el informe de ensayo correspondiente en el cual se indican los resultados obtenidos en cada ensayo.

Los resultados obtenidos en estos ensayos solo se refieren a la(s) muestra(s) analizada(s) en este Centro en la fecha indicada y no implican una característica de constancia en la calidad de la producción



Fdo: Asier Maiztegi  
Director Dpto. Construcción



# Certificado de Ensayos

<b>EMPRESA</b>	<b>SISTEMAS VALLE LENIZ, S.A.</b>
<b>DIRECCIÓN</b>	<b>Pol. Ind. Arbi-Zelai s/n 20550 ARETXABALETA (GIPUZKOA) SPAIN</b>
<b>NºCERTIFICADO</b>	<b>18146 (2/2)</b>

## ÁREA DE APLICACIÓN

La cerradura de embutir con palanca deslizante de referencia “**192/35/6**” es la combinación más desfavorable de la serie **184-192**, que consiste en varias referencias que siguen el siguiente esquema:

**192 xyy/z**

**184 xyy/z**

donde:

<b>192:</b> Distancia entre ejes	▪ 92 mm	
<b>184:</b> Distancia entre ejes	▪ 85 mm	
<b>x:</b> tipo de cerradura	▪ /: picaporte y palanca	
	▪ A: palanca	
	▪ C: muletilla	
<b>yy:</b> entrada	▪ 23	▪ 30
	▪ 25	▪ 33
	▪ 28	▪ 35
<b>Z:</b> material	▪ 0: hierro niquelado	
	▪ 6: acero inoxidable	

Por lo tanto, se deduce que la clasificación obtenida por la referencia **192/35/6** y mostrada en la página anterior puede aplicarse a todas las referencias pertenecientes a esta serie.

<b>FECHA</b>	<b>18 de julio de 2008</b>
--------------	----------------------------

Este documento no tiene validez sin el informe de ensayo correspondiente en el cual se indican los resultados obtenidos en cada ensayo.

Los resultados obtenidos en estos ensayos solo se refieren a la(s) muestra(s) analizada(s) en este Centro en la fecha indicada y no implican una característica de constancia en la calidad de la producción



Asier Maiztegi  
Director Dpto. Construcción



## PALANCA DESLIZANTE ENTRE EJES 85 mm.

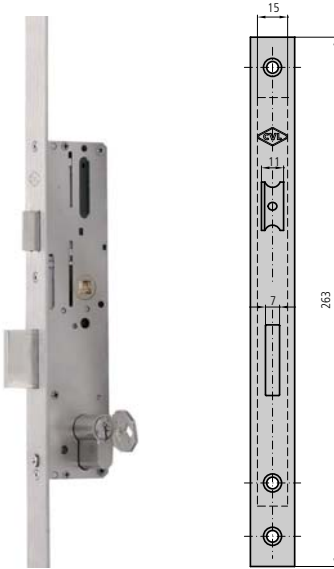

SERIE 1E5 **Soft**

## CARACTERÍSTICAS

- Máxima suavidad mediante engranajes
- Cerradura de 1 punto con frente liso inox de 16 mm, 22 mm, 24 mm y U 24,5\*6
- Picaporte reversible y regulable de 11 mm
- Mínimo stock: 3 versiones en 1 cerradura (picaporte/rodillo/sólo palanca)
- Palanca deslizante
- Diseño según norma EN12209 y pr. EN 15685
- Caja cerrada de 15 mm
- Cuadradillo de 8 mm
- Tornillo de fijación de cilindro
- 2 terminales de frente de nylon ref. EMB196 para frente liso (para frente de 22 mm.)

## ACCESORIOS OPCIONALES

- Gama completa de cerraderos (ver página 42 - 48)
- Gama completa de cilindros (ver página 122 - 142)

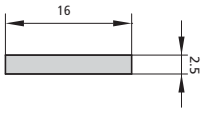
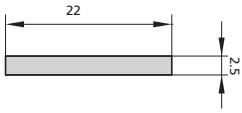
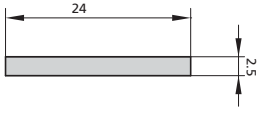
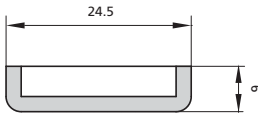
DESCRIPCIÓN	REF.	MEDIDAS		LEVA	ACABADOS		UDS	
		B	A		FRENTE	CILINDRO		
	P1E5/30/6	27	43	15	Al		1	
	P1E5/35/6	32	48	15	Al		1	
	P1E5/40/6	37	53	15	Al		1	
	P1E5/50/6	47	63	15	Al		1	
<ul style="list-style-type: none"> <li>• Picaporte y palanca</li> <li>• No incluye cilindro</li> </ul> <b>Opciones de cerradero</b> (ver página 42 - 48) 	1E5/30/6	27	43	15	Al		1	
	1E5/35/6	32	48	15	Al		1	
	1E5/40/6	37	53	15	Al		1	
	1E5/50/6	47	63	15	Al		1	
	1E5/30/6AN	27	43	15	Al		1	
	1E5/35/6AN	32	48	15	Al		1	
	1E5/40/6AN	37	53	15	Al		1	
	1E5/50/6AN	47	63	15	Al		1	
	1E5/30/6U	23	39	15	Al		1	
	1E5/35/6U	28	44	15	Al		1	
	1E5/40/6U	33	49	15	Al		1	
	1E5/50/6U	43	59	15	Al		1	

**MULTIPUNTO PALANCA DESLIZANTE ENTRE EJES 85 mm.**

**SERIE 2E5 Soft**

**CARACTERÍSTICAS**

- Máxima suavidad mediante engranajes
- Cerradura de 3 puntos con frente liso inox de 16 mm, 22 mm, 24 mm y U 24,5\*6
- Frente de 1850 mm de largo
- Picaporte reversible y regulable de 11 mm
- Mínimo stock: 3 versiones en 1 cerradura (picaporte/rodillo/sólo palanca)
- Palanca deslizante
- Diseño según norma EN12209 y pr. EN 15685
- Caja cerrada de 15 mm
- Cuadradillo de 8 mm
- Tornillo de fijación de cilindro

**ACCESORIOS OPCIONALES**

- Gama completa de cerraderos (ver páginas 42 - 48)
- Gama completa de cilindros (ver páginas 122 - 142)
- Frente de 2300 mm de largo opcional (serie 4E5)
- Frente de 1500 mm de largo opcional (serie 5E5)

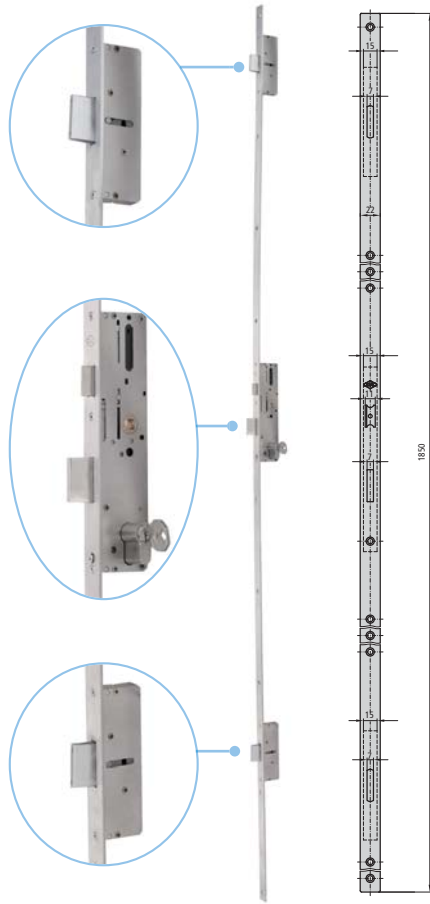

**DESCRIPCIÓN**

**REF.**

**MEDIDAS  
B A**

**LEVA**

**ACABADOS  
FRENTE CILINDRO**

**UDS**



- Picaporte y palanca
- Cilindro no incluido

**Opciones de cerradero**  
(ver páginas 42 - 48)

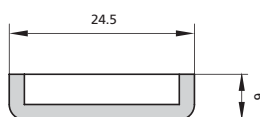
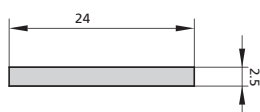
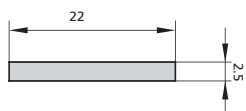
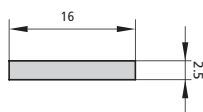

P2E5/30/6	27	43	15	Al	1
P2E5/35/6	32	48	15	Al	1
P2E5/40/6	37	53	15	Al	1
P2E5/50/6	47	63	15	Al	1
2E5/30/6L	27	43	15	Al	1
2E5/35/6L	32	48	15	Al	1
2E5/40/6L	37	53	15	Al	1
2E5/50/6L	47	63	15	Al	1
2E5/30/6LAN	27	43	15	Al	1
2E5/35/6LAN	32	48	15	Al	1
2E5/40/6LAN	37	53	15	Al	1
2E5/50/6LAN	47	63	15	Al	1
2E5/30/6U	23	39	15	Al	1
2E5/35/6U	28	44	15	Al	1
2E5/40/6U	33	49	15	Al	1
2E5/50/6U	43	59	15	Al	1

## PALANCA DESLIZANTE ENTRE EJES 92 mm

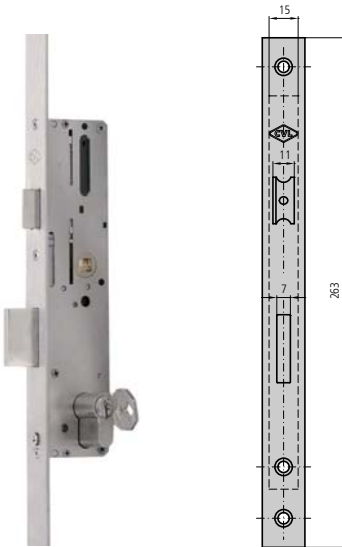
SERIE 1E2 **Soft**

## CARACTERÍSTICAS

- Máxima suavidad entre engranajes
- Frente liso inox de 16 mm, 22 mm, 24 mm y U 24,5\*6
- Picaporte reversible y regulable de 11 mm
- Mínimo stock: 3 versiones en 1 cerradura (picaporte/rodillo/sólo palanca)
- Palanca deslizante
- Diseño según norma EN12209 y pr. EN 15685
- Caja cerrada de 15 mm
- Cuadradillo de 8 mm
- Tornillo de fijación de cilindro
- 2 terminales de frente de nylon ref. EMB196 para frente liso (para frente de 22 mm.)

## ACCESORIOS OPCIONALES

- Gama completa de cerraderos (ver páginas 42 - 48)
- Gama completa de cilindros (ver páginas 122 - 142)

DESCRIPCIÓN	REF.	MEDIDAS		LEVA	ACABADOS		UDS		
		B	A		FRENTE	CILINDRO			
	P1E2/30/6	27	43	15	Al			1	
	P1E2/35/6	32	48	15	Al			1	
	P1E2/40/6	37	53	15	Al			1	
	P1E2/50/6	47	63	15	Al			1	
	1E2/30/6	27	43	15	Al			1	
	1E2/35/6	32	48	15	Al			1	
	1E2/40/6	37	53	15	Al			1	
	1E2/50/6	47	63	15	Al			1	
	1E2/30/6AN	27	43	15	Al			1	
	1E2/35/6AN	32	48	15	Al			1	
	1E2/40/6AN	37	53	15	Al			1	
	1E2/50/6AN	47	63	15	Al			1	
	1E2/30/6U	23	39	15	Al			1	
	1E2/35/6U	28	44	15	Al			1	
	1E2/40/6U	33	49	15	Al			1	
	1E2/50/6U	43	59	15	Al			1	

- Picaporte y palanca
- Cilindro no incluido

**Opciones de cerradero**  
(ver páginas 42 - 48)

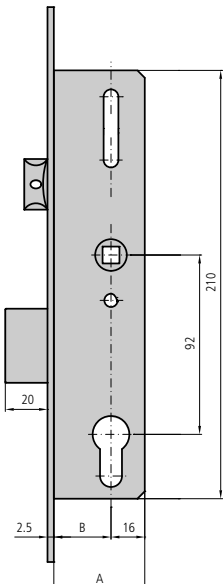

**MULTIPUNTO PALANCA DESLIZANTE ENTRE EJES 92 mm**

**SERIE 2E2 *Soft***

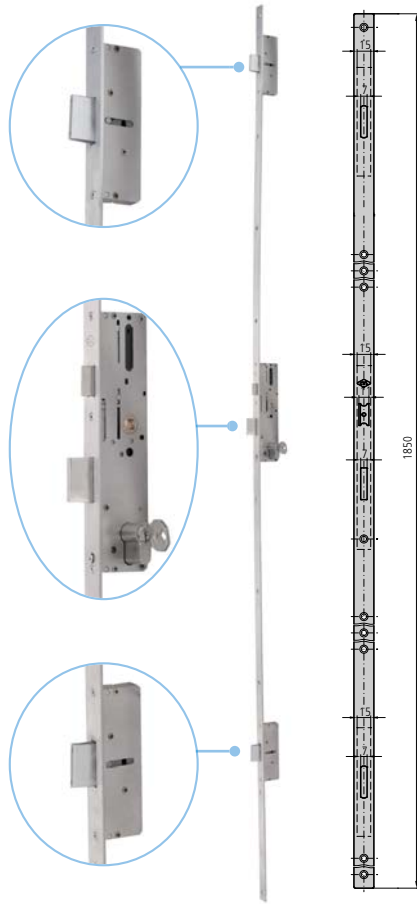

**CARACTERÍSTICAS**

- Máxima suavidad entre engranajes
- Cerradura de 3 puntos con frente liso inox de 16 mm, 22 mm, 24 mm y U 24,5\*6
- Frente de 1850 mm de largo
- Picaporte reversible y regulable de 11 mm
- Mínimo stock: 3 versiones en 1 cerradura (picaporte/rodillo/sólo palanca)
- Palanca deslizante
- Diseño según norma EN12209 y pr. EN 15685
- Caja cerrada de 15 mm
- Cuadradillo de 8 mm
- Tornillo de fijación de cilindro

**ACCESORIOS OPCIONALES**

- Gama completa de cerraderos (ver páginas 42 - 48)
- Gama completa de cilindros (ver páginas 122 - 142)
- Frente de 2300 mm de largo opcional (serie 4E2)
- Frente de 1500 mm de largo opcional (serie 5E2)

DESCRIPCIÓN	REF.	MEDIDAS		LEVA	ACABADOS		UDS	
		B	A		FRENTE	CILINDRO		

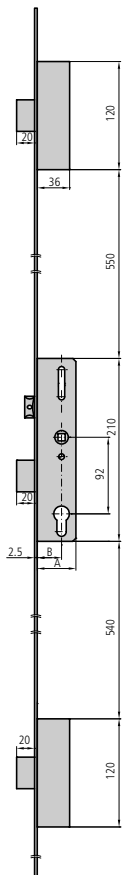

- Picaporte y palanca
- Cilindro no incluido

**Opciones de cerradero**  
(ver páginas 42 - 48)

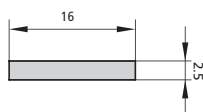

P2E2/30/6	27	43	15	Al	1
P2E2/35/6	32	48	15	Al	1
P2E2/40/6	37	53	15	Al	1
P2E2/50/6	47	63	15	Al	1

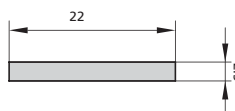

2E2/30/6L	27	43	15	Al	1
2E2/35/6L	32	48	15	Al	1
2E2/40/6L	37	53	15	Al	1
2E2/50/6L	47	63	15	Al	1

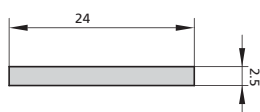

2E2/30/6LAN	27	43	15	Al	1
2E2/35/6LAN	32	48	15	Al	1
2E2/40/6LAN	37	53	15	Al	1
2E2/50/6LAN	47	63	15	Al	1

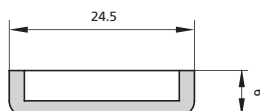

2E2/30/6U	23	39	15	Al	1
2E2/35/6U	28	44	15	Al	1
2E2/40/6U	33	49	15	Al	1
2E2/50/6U	43	59	15	Al	1



Novedad



## PALANCA BASCULANTE ENTRE EJES 85 mm.

## SERIE 1K5 DUE

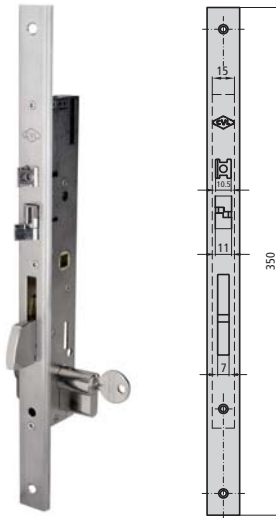

## CARACTERÍSTICAS

- Cerradura eléctrica 12V con apertura eléctrica automática con manilla o con cilindro
- Cerradura de 1 punto con frente liso inox de 16 mm, 22 mm, 24 mm y U 24,5\*6
- Sistema antitarjeta
- Compatible para CA y CC
- Mínimo esfuerzo para cierre de puerta
- Caja de 15 mm
- Cuadradillo de 8 mm
- 2 escudos de nylon ref. ES1984
- Cerraderos de serie según cerradura
- Tornillo de fijación de cilindro
- 2 terminales de frente de nylon ref. EMB196 para frente liso (para frente de 22 mm.)

## ACCESORIOS OPCIONALES

- Gama completa de cerraderos (ver páginas 42 - 48)
- Gama completa de cilindros (ver páginas 122 - 142)

## DESCRIPCIÓN

## REF.

## MEDIDAS

## LEVA

## ACABADOS

## UDS

B

A

FRENTE CILINDRO

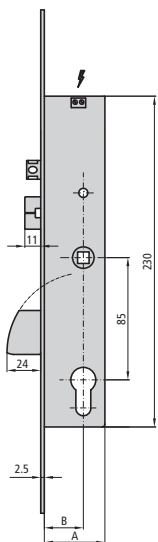

- Picaporte y palanca
- Cilindro no incluido
- Incluye cerradero Ref. KCE1K5/6L

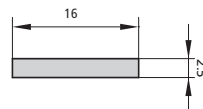

P1K5/30/6

27

42

15

Al

1

P1K5/35/6

32

47

15

Al

1

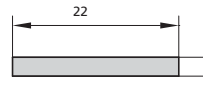

1K5/30/6

27

42

15

Al

1

1K5/33/6

30

43

13,25

Al

1

1K5/35/6

32

47

15

Al

1

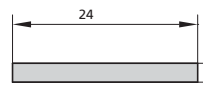

1K5/30/6AN

27

42

15

Al

1

1K5/33/6AN

30

43

13,25

Al

1

1K5/35/6AN

32

47

15

Al

1

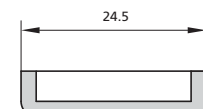

1K5/30/6U

23

38

15

Al

1

1K5/35/6U

28

43



15

Al

1

**PALANCA BASCULANTE ENTRE EJES 85 mm.**

**SERIE 1K5 DUE**

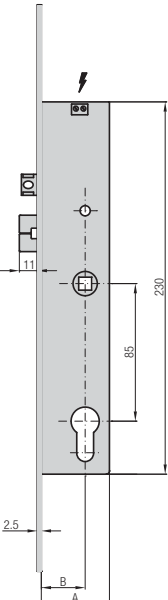
DESCRIPCIÓN	REF.	MEDIDAS		LEVA	ACABADOS		UDS	
		B	A		FRENTE	CILINDRO		
 <ul style="list-style-type: none"> <li>• Sólo picaporte</li> <li>• Cilindro no incluido</li> <li>• Incluye cerradero Ref. KCE1K5T/6L</li> </ul>								

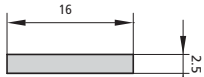

P1K5T/30/6	27	42	15	Al	1
P1K5T/35/6	32	47	15	Al	1

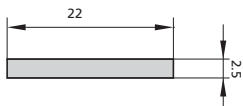

1K5T/30/6	27	42	15	Al	1
1K5T/33/6	30	43	13,25	Al	1
1K5T/35/6	32	47	15	Al	1

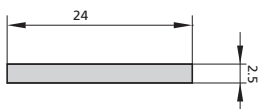

1K5T/30/6AN	27	42	15	Al	1
1K5T/33/6AN	30	43	13,25	Al	1
1K5T/35/6AN	32	47	15	Al	1

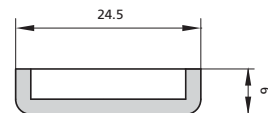

1K5T/30/6U	23	38	15	Al	1
1K5T/35/6U	28	43	15	Al	1

**MULTIPUNTO PALANCA BASCULANTE ENTRE EJES 85 mm.**
**SERIE 2K5 DUE**
**CARACTERÍSTICAS**

- Cerradura eléctrica 12V con apertura eléctrica automática con manilla o con cilindro
- Cerradura de 3 puntos con frente liso inox de 16 mm, 22 mm, 24 mm y U 24,5\*6
- Frente de 1850 mm de largo
- Sistema antitarjeta
- Compatible para CA y CC
- Mínimo esfuerzo para cierre de puerta
- Caja de 15 mm
- Cuadradillo de 8 mm
- Escudo de seguridad pasante ref. BT1196/1N
- Cerraderos de serie según cerradura
- Tornillo de fijación de cilindro

**ACCESORIOS OPCIONALES**

- Gama completa de cerraderos (ver páginas 42 - 48)
- Gama completa de cilindros (ver páginas 122 - 142)
- Frente de 2300 mm de largo opcional (serie 4K5)
- Frente de 1500 mm de largo opcional (serie 5K5)

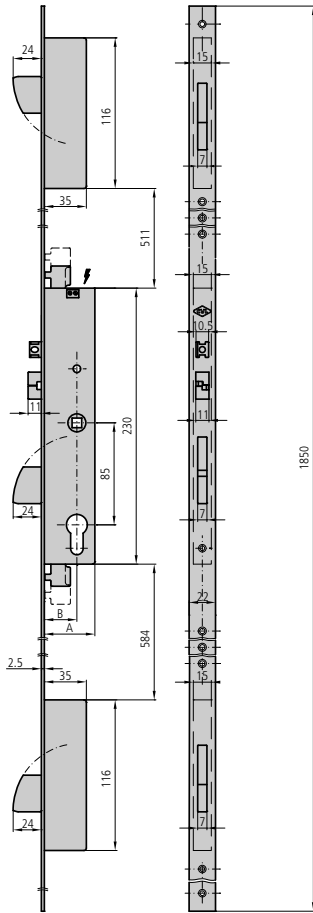
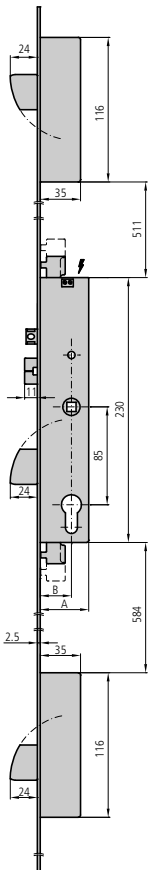
**DESCRIPCIÓN**
**REF.**
**MEDIDAS**
**LEVA**
**ACABADOS**
**UDS**
**B A**
**FRENTE CILINDRO**

- Picaporte y palanca
- Cilindro no incluido
- Incluye cerradero ref. KCE1K5/6L
- 2 unidades alto/bajo: CE296S/6L

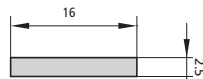

P2K5/30/6 27 42 15 Al 1

P2K5/35/6 32 47 15 Al 1



2K5/30/6L 27 42 15 Al 1

2K5/33/6L 30 43 13,25 Al 1

2K5/35/6L 32 47 15 Al 1

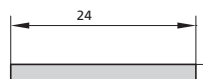

2K5/30/6LAN 27 42 15 Al 1

2K5/33/6LAN 30 43 13,25 Al 1

2K5/35/6LAN 32 47 15 Al 1

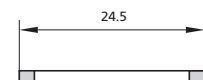

2K5/30/6U 23 38 15 Al 1

2K5/35/6U 28 43 15 Al 1

**PALANCA BASCULANTE ENTRE EJES 92 mm.**

**SERIE 1K2 DUE**

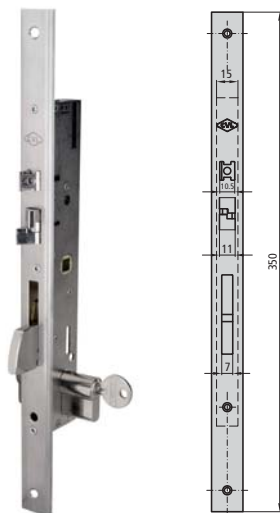

**CARACTERÍSTICAS**

- Cerradura eléctrica 12V con apertura eléctrica automática con manilla o con cilindro
- Cerradura de 1 punto con frente liso inox de 16 mm, 22 mm, 24 mm y U 24,5\*6
- Sistema antitarjeta
- Compatible para CA y CC
- Mínimo esfuerzo para cierre de puerta
- Caja de 15 mm
- Cuadradillo de 8 mm
- 2 escudos de nylon ES1984
- Cerraderos de serie según cerradura
- Tornillo de fijación de cilindro
- 2 terminales de frente de nylon ref. EMB196 para frente liso (para frente de 22 mm.)

**ACCESORIOS OPCIONALES**

- Gama completa de cerraderos (ver páginas 42 - 48)
- Gama completa de cilindros (ver páginas 122 - 142)

DESCRIPCIÓN	REF.	MEDIDAS		LEVA	ACABADOS		UDS	
		B	A		FRENTE	CILINDRO		

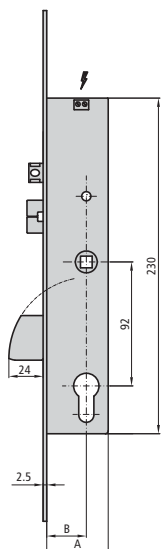

- Picaporte y palanca
- Cilindro no incluido
- Incluye cerradero ref. KCE1K2/6L

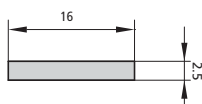

P1K2/30/6	27	42	15	Al	1
P1K2/35/6	32	47	15	Al	1

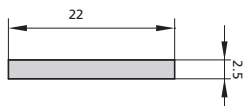

1K2/30/6	27	42	15	Al	1
1K2/33/6	30	43	13,25	Al	1
1K2/35/6	32	47	15	Al	1

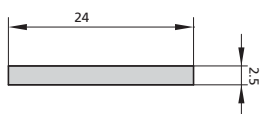

1K2/30/6AN	27	42	15	Al	1
1K2/33/6AN	30	43	13,25	Al	1
1K2/35/6AN	32	47	15	Al	1

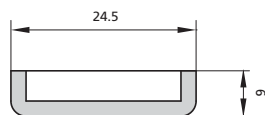

1K2/30/6U	23	38	15	Al	1
1K2/35/6U	28	43	15	Al	1



Novedad



## PALANCA BASCULANTE ENTRE EJES 92 mm.

SERIE 1K2 DUE

DESCRIPCIÓN

REF.

MEDIDAS

LEVA

ACABADOS  
FRENTE CILINDRO

UDS

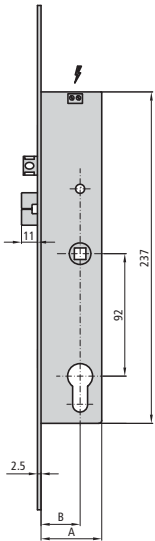

- Sólo picaporte
- Cilindro no incluido
- Incluye cerradero ref. KCE1K5T/6L

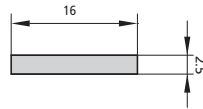

P1K2T/30/6	27	42	15	Al	1
P1K2T/35/6	32	47	15	Al	1

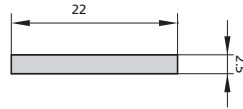

1K2T/30/6	27	42	15	Al	1
1K2T/33/6	30	43	13,25	Al	1
1K2T/35/6	32	47	15	Al	1

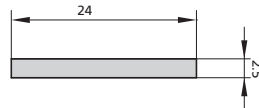

1K2T/30/6AN	27	42	15	Al	1
1K2T/33/6AN	30	43	13,25	Al	1
1K2T/35/6AN	32	47	15	Al	1

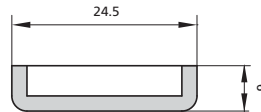

1K2T/30/6U	23	38	15	Al	1
1K2T/35/6U	28	43	15	Al	1

**MULTIPUNTO PALANCA BASCULANTE ENTRE EJES 92 mm. SERIE 2K2 DUE**

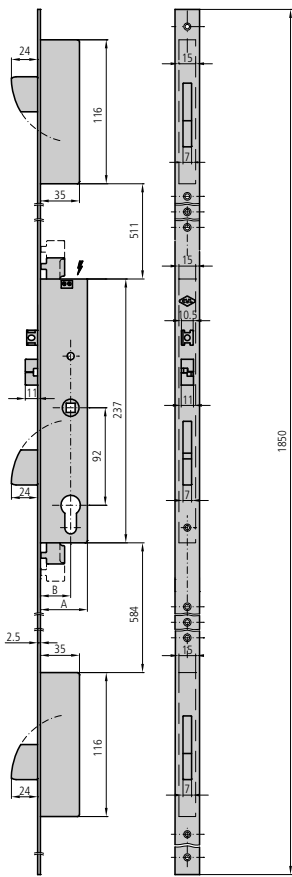

**CARACTERÍSTICAS**

- Cerradura eléctrica 12V con apertura eléctrica automática con manilla o con cilindro
- Cerradura de 3 puntos con frente liso inox de 16 mm, 22 mm, 24 mm y U 24,5\*6
- Frente de 1850 mm de largo
- Sistema antitarjeta
- Compatible con CA y CC
- Mínimo esfuerzo para cierre de puerta
- Caja de 15 mm
- Cuadradillo de 8 mm
- Escudo de seguridad pasante ref. BT1196/1N
- Cerraderos de serie según cerradura
- Tornillo de fijación de cilindro

**ACCESORIOS OPCIONALES**

- Gama completa de cerraderos (ver páginas 42 - 48)
- Gama completa de cilindros (ver páginas 122 - 142)
- Frente de 2300 mm de largo opcional (serie 4K2)
- Frente de 1500 mm de largo opcional (serie 5K2)

DESCRIPCIÓN	REF.	MEDIDAS		LEVA	ACABADOS		UDS	
		B	A		FRENTE	CILINDRO		

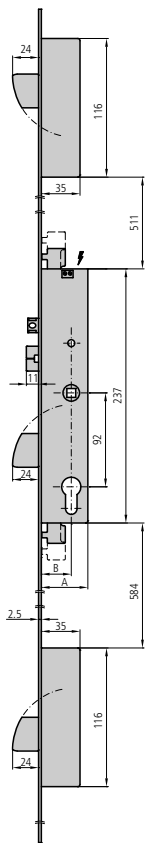

- Picaporte y palanca
- Cilindro no incluido
- Incluye cerradero central ref. KCE1K5/6L
- 2 unidades alto/bajo: CE296S/6L

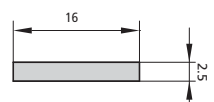

P2K2/30/6	27	42	15	Al	1
P2K2/35/6	32	47	15	Al	1

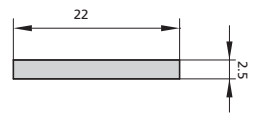

2K2/30/6L	27	42	15	Al	1
2K2/33/6L	30	43	13,25	Al	1
2K2/35/6L	32	47	15	Al	1

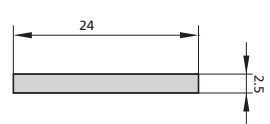

2K2/30/6LAN	27	42	15	Al	1
2K2/33/6LAN	30	43	13,25	Al	1
2K2/35/6LAN	32	47	15	Al	1

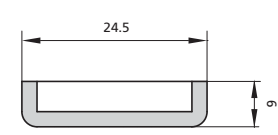

2K2/30/6U	23	38	15	Al	1
2K2/35/6U	28	43	15	Al	1

## MULTIPUNTO PALANCA DESLIZANTE ENTRE EJES 92 mm.

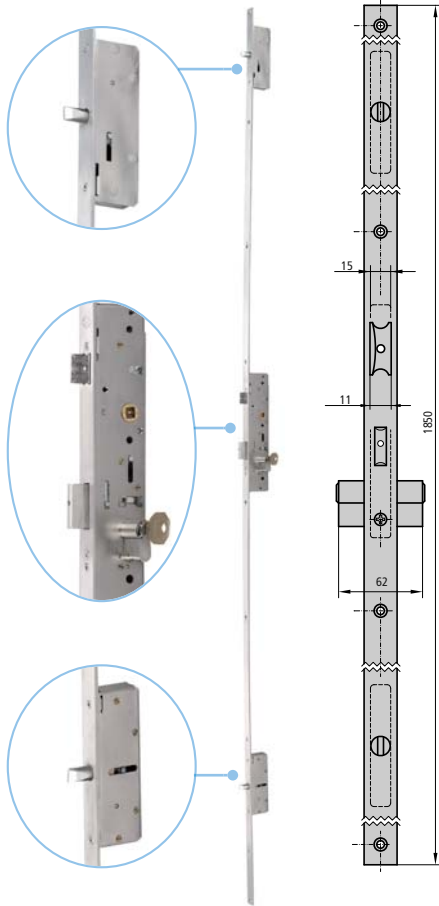
SERIE 202 **inve**se

## CARACTERÍSTICAS

- Cerradura de 3 puntos con facilidad de cierre mediante manilla hacia arriba y bloqueo mediante llave
- Frente liso inox de 16 mm, 22 mm, 24 mm y U 24,5\*6
- Frente de 1850 mm de largo
- Picaorte de 11 mm reversible y regulable
- Palanca central deslizante reforzada
- Caja cerrada de 15 mm
- Cuadradillo de 8 mm
- Tornillo de fijación de cilindro

## ACCESORIOS OPCIONALES

- Gama completa de cerraderos (ver páginas 42 - 48)
- Gama completa de cilindros (ver páginas 122 - 142)
- Frente de 2300 mm de largo opcional (serie 402)
- Frente de 1500 mm de largo opcional (serie 502)

## DESCRIPCIÓN

## REF.

## MEDIDAS

## LEVA

## ACABADOS

## UDS

B A

FRENTE CILINDRO

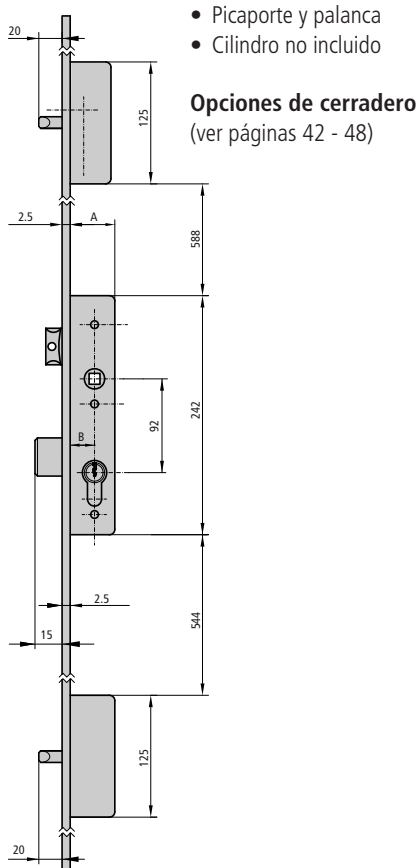

- Picaorte y palanca
- Cilindro no incluido

Opciones de cerradero  
(ver páginas 42 - 48)

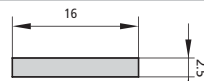

P202/30/6	27	42	15	Al	1
P202/33/6	30	45	15	Al	1
P202/35/6	32	47	15	Al	1

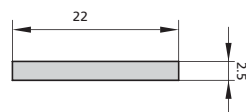

202/30/6L	27	42	15	Al	1
202/33/6L	30	45	15	Al	1
202/35/6L	32	47	15	Al	1

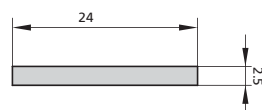

202/30/6LAN	27	42	15	Al	1
202/33/6LAN	30	45	15	Al	1
202/35/6LAN	32	47	15	Al	1

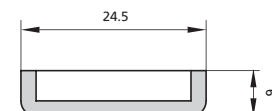

202/30/6U	23	38	15	Al	1
202/33/6U	26	41	15	Al	1
202/35/6U	28	43	15	Al	1

**MULTIPUNTO PALANCA DESLIZANTE ENTRE EJES 92 mm.**

**SERIE 302 *inve@se***

**CARACTERÍSTICAS**

- Cerradura de 3 puntos central y alto/bajo con facilidad de cierre mediante manilla hacia arriba y bloqueo mediante llave
- Frente liso inox de 16 mm, 22 mm, 24 mm y U 24,5\*6
- Frente de 350 mm de largo
- Picaporte de 11 mm reversible y regulable
- Palanca central deslizante reforzada
- Caja cerrada de 15 mm
- Cuadradillo de 8 mm
- 2 escudos de nylon ref. ES1984
- Tornillo de fijación de cilindro

**ACCESORIOS OPCIONALES**

- Gama completa de cerraderos (ver páginas 42 - 48)
- Gama completa de cilindros (ver páginas 122 - 142)
- Poliamida extrudida POLCE (ver página 51)

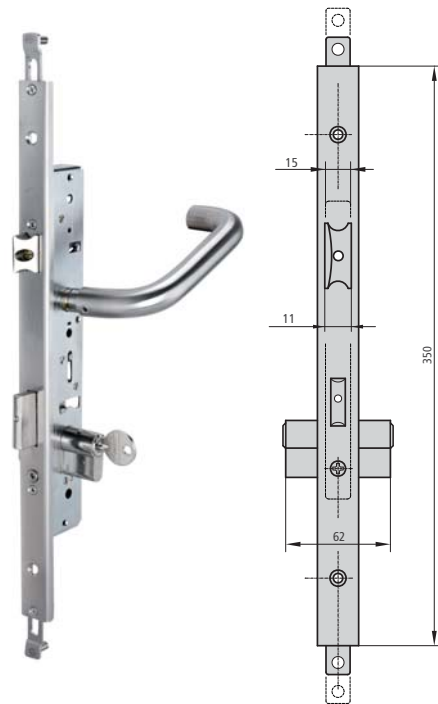

**DESCRIPCIÓN**

**REF.**

**MEDIDAS**

**LEVA**

**ACABADOS**  
FRENTE CILINDRO

**UDS**



- Picaporte y palanca
- Cilindro no incluido

**Opciones de cerradero**  
(ver páginas 42 - 48)

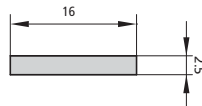
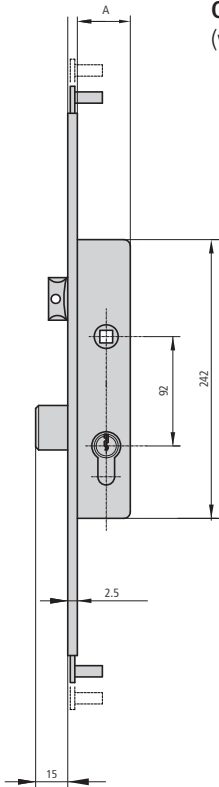

P302/30/6	27	42	15	Al	1	10
P302/33/6	30	45	15	Al	1	10
P302/35/6	32	47	15	Al	1	10

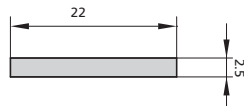

302/30/6L	27	42	15	Al	1	10
302/33/6L	30	45	15	Al	1	10
302/35/6L	32	47	15	Al	1	10

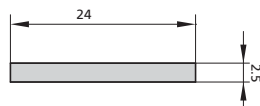

302/30/6LAN	27	42	15	Al	1	10
302/33/6LAN	30	45	15	Al	1	10
302/35/6LAN	32	47	15	Al	1	10

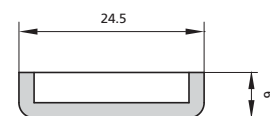

302/30/6U	23	38	15	Al	1	10
302/33/6U	26	41	15	Al	1	10
302/35/6U	28	43	15	Al	1	10



## PALANCA DESLIZANTE ENTRE EJES 85 mm.

## SERIE 184

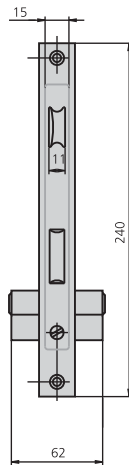



## CARACTERÍSTICAS

- Frente de 22 mm ó 24 mm
- Picaporte reversible de 11 mm
- Caja de 15 mm
- Cuadrado de 8 mm
- 2 escudos de nylon ref. E51984
- 2 terminales de frente de nylon ref. EMB196 (para frente de 22 mm)
- Tornillo de fijación de cilindro

## ACCESORIOS OPCIONALES

- Gama completa de cerraderos (ver páginas 42 - 48)
- Gama completa de cilindros (ver páginas 122 - 142)

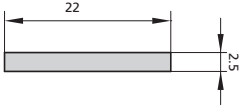
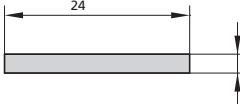
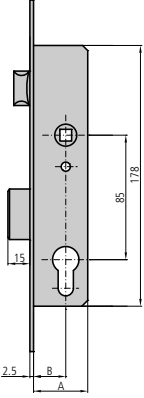
DESCRIPCIÓN	REF.	MEDIDAS		LEVA	ACABADOS		UDS	
		B	A		FRENTE	CILINDRO		
								
	184/23/0	20	33	13,25	HN	CN	1	20
	184/23/6	20	33	13,25	AI	CN	1	20
	184/25/0	22	37	15	HN	CN	1	20
	184/25/6	22	37	15	AI	CN	1	20
	184/28/0	25	38	13,25	HN	CN	1	20
	184/28/6	25	38	13,25	AI	CN	1	20
	184/30/0	27	42	15	HN	CN	1	20
	184/30/6	27	42	15	AI	CN	1	20
	184/33/0	30	43	13,25	HN	CN	1	20
	184/33/6	30	43	13,25	AI	CN	1	20
	184/35/0	32	47	15	HN	CN	1	20
	184/35/6	32	47	15	AI	CN	1	20
	184/38/0	35	48	13,25	HN	CN	1	20
	184/38/6	35	48	13,25	AI	CN	1	20
								
 <ul style="list-style-type: none"> <li>• Picaporte y palanca</li> <li>• Cilindros de leva larga 5982/2525/4 o de leva corta 5990/2525/4</li> </ul> <p><b>Opciones de cerradero</b> (ver páginas 42 - 48)</p> <p><b>Opción cerraderos eléctricos</b> (ver página 49)</p>								
	184/23/0AN	20	33	13,25	HN	CN	1	20
	184/23/6AN	20	33	13,25	AI	CN	1	20
	184/25/0AN	22	37	15	HN	CN	1	20
	184/25/6AN	22	37	15	AI	CN	1	20
	184/28/0AN	25	38	13,25	HN	CN	1	20
	184/28/6AN	25	38	13,25	AI	CN	1	20
	184/30/0AN	27	42	15	HN	CN	1	20
	184/30/6AN	27	42	15	AI	CN	1	20
	184/33/0AN	30	43	13,25	HN	CN	1	20
	184/33/6AN	30	43	13,25	AI	CN	1	20
	184/35/0AN	32	47	15	HN	CN	1	20
	184/35/6AN	32	47	15	AI	CN	1	20
	184/38/0AN	35	48	13,25	HN	CN	1	20
	184/38/6AN	35	48	13,25	AI	CN	1	20

**PALANCA DESLIZANTE ENTRE EJES 85 mm.**
**SERIE 184**

DESCRIPCIÓN	REF.	MEDIDAS		LEVA	ACABADOS		UDS		
		B	A		FRENTE	CILINDRO			
<ul style="list-style-type: none"> <li>• Sólo palanca</li> <li>• Cilindros de leva larga 5982/2525/4 o de leva corta 5990/2525/4</li> </ul> <p><b>Opciones de cerradero</b> (ver páginas 42 - 48)</p>	184A23/0	20	33	13,25	HN	CN	1	30	
	184A23/6	20	33	13,25	AI	CN	1	30	
	184A25/0	22	37	15	HN	CN	1	30	
	184A25/6	22	37	15	AI	CN	1	30	
	184A28/0	25	38	13,25	HN	CN	1	30	
	184A28/6	25	38	13,25	AI	CN	1	30	
	184A30/0	27	42	15	HN	CN	1	30	
	184A30/6	27	42	15	AI	CN	1	30	
	184A33/0	30	43	13,25	HN	CN	1	30	
	184A33/6	30	43	13,25	AI	CN	1	30	
	184A35/0	32	47	15	HN	CN	1	30	
	184A35/6	32	47	15	AI	CN	1	30	
	184A38/0	35	48	13,25	HN	CN	1	30	
	184A38/6	35	48	13,25	AI	CN	1	30	
	<p><b>Opciones de cerradero</b> (ver páginas 42 - 48)</p>	184A23/0AN	20	33	13,25	HN	CN	1	30
		184A23/6AN	20	33	13,25	AI	CN	1	30
184A25/0AN		22	37	15	HN	CN	1	30	
184A25/6AN		22	37	15	AI	CN	1	30	
184A28/0AN		25	38	13,25	HN	CN	1	30	
184A28/6AN		25	38	13,25	AI	CN	1	30	
184A30/0AN		27	42	15	HN	CN	1	30	
184A30/6AN		27	42	15	AI	CN	1	30	
184A33/0AN		30	43	13,25	HN	CN	1	30	
184A33/6AN		30	43	13,25	AI	CN	1	30	
184A35/0AN		32	47	15	HN	CN	1	30	
184A35/6AN		32	47	15	AI	CN	1	30	
184A38/0AN		35	48	13,25	HN	CN	1	30	
184A38/6AN		35	48	13,25	AI	CN	1	30	

<ul style="list-style-type: none"> <li>• Con condena</li> </ul> <p><b>Opciones de cerradero</b> (ver páginas 42 - 48)</p>	184C23/6	20	33		AI		2	40	
	184C25/6	22	37		AI		2	40	
	184C28/6	25	38		AI		2	40	
	184C30/6	27	42		AI		2	40	
	184C33/6	30	43		AI		2	40	
	184C35/6	32	47		AI		2	40	
	184C38/6	35	48		AI		2	40	
		184C23/6AN	20	33		AI		2	40
		184C25/6AN	22	37		AI		2	40
		184C28/6AN	25	38		AI		2	40
184C30/6AN		27	42		AI		2	40	
184C33/6AN		30	43		AI		2	40	
184C35/6AN		32	47		AI		2	40	
184C38/6AN		35	48		AI		2	40	

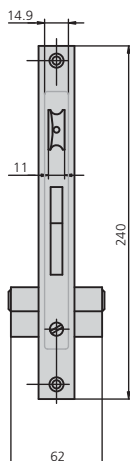

**PALANCA BASCULANTE ENTRE EJES 85 mm.**
**SERIE 196**

**CARACTERÍSTICAS**

- Frente inox de 22 mm o 24 mm o frente U de 24,5 x 6
- Picaporte reversible de 11 mm
- Picaporte regulable excepto en entrada 25 mm y 28 mm
- Caja de 15 mm
- Cuadradillo de 8 mm
- 2 escudos de nylon ref. ES1984
- 2 terminales de frente de nylon ref. EMB196 (para frente de 22 mm)
- Tornillo de fijación de cilindro

**ACCESORIOS OPCIONALES**



- Gama completa de cerraderos (ver páginas 42 - 48)
- Gama completa de cerraderos (ver páginas 122 - 142)
- Escudo de seguridad pasante BTI296/1N (ver página 51)

DESCRIPCIÓN	REF.	MEDIDAS		LEVA	ACABADOS		UDS	
		B	A		FRENTE	CILINDRO		
<ul style="list-style-type: none"> <li>• Picaporte y palanca</li> <li>• Cilindro de leva larga 5982/2525/4 o de leva corta 5990/2525/4</li> </ul>	196/25/6	22	37	15	AI	CN	1	20
	196/28/6	25	38	13,25	AI	CN	1	20
	196/30/6	27	42	15	AI	CN	1	20
	196/33/6	30	43	13,25	AI	CN	1	20
	196/35/6	32	47	15	AI	CN	1	20
	196/38/6	35	48	13,25	AI	CN	1	20
	<p><b>Opciones de cerradero</b> (ver páginas 42 - 48)</p> <p><b>Opción cerradero eléctrico</b> (ver página 49)</p>	196/25/6AN	22	37	15	AI	CN	1
196/28/6AN		25	38	13,25	AI	CN	1	20
196/30/6AN		27	42	15	AI	CN	1	20
196/33/6AN		30	43	13,25	AI	CN	1	20
196/35/6AN		32	47	15	AI	CN	1	20
196/38/6AN		35	48	13,25	AI	CN	1	20
		196/25/6U	18	33	15	AI	CN	1
	196/30/6U	23	38	15	AI	CN	1	20
	196/35/6U	28	43	15	AI	CN	1	20



## PALANCA BASCULANTE ENTRE EJES 85 mm.

## SERIE 196

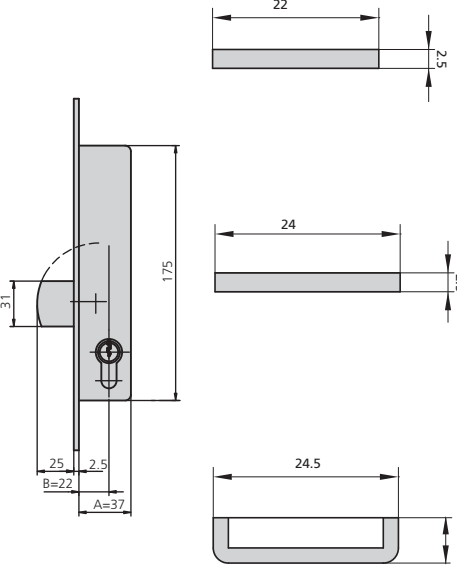
DESCRIPCIÓN	REF.	MEDIDAS		LEVA	ACABADOS		UDS	
		B	A		FRENTE	CILINDRO		
	196A25/6	22	37	15	Al	CN	1	20
	196A28/6	25	38	13,25	Al	CN	1	20
	196A30/6	27	42	15	Al	CN	1	20
	196A33/6	30	43	13,25	Al	CN	1	20
	196A35/6	32	47	15	Al	CN	1	20
	196A38/6	35	48	13,25	Al	CN	1	20
	196A25/6AN	22	37	15	Al	CN	1	20
	196A28/6AN	25	38	13,25	Al	CN	1	20
	196A30/6AN	27	42	15	Al	CN	1	20
	196A33/6AN	30	43	13,25	Al	CN	1	20
	196A35/6AN	32	47	15	Al	CN	1	20
	196A38/6AN	35	48	13,25	Al	CN	1	20
	196A25/6U	18	33	15	Al	CN	1	20
	196A30/6U	23	38	15	Al	CN	1	20
	196A35/6U	28	43	15	Al	CN	1	20

- Sólo palanca
- Cilindro de leva larga 5982/2525/4 o de leva corta 5990/2525/4

## Opciones de cerradero

(ver páginas 42 - 48)

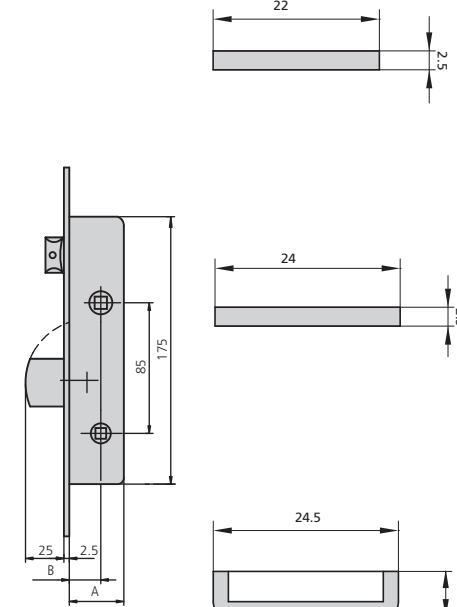
	196C25/6	22	37		Al		2	40
	196C28/6	25	38		Al		2	40
	196C30/6	27	42		Al		2	40
	196C33/6	30	43		Al		2	40
	196C35/6	32	47		Al		2	40
	196C38/6	35	48		Al		2	40
	196C25/6AN	22	37		Al		2	40
	196C28/6AN	25	38		Al		2	40
	196C30/6AN	27	42		Al		2	40
	196C33/6AN	30	43		Al		2	40
	196C35/6AN	32	47		Al		2	40
	196C38/6AN	35	48		Al		2	40
	196C25/6U	18	33		Al		2	40
	196C30/6U	23	38		Al		2	40
	196C35/6U	28	43		Al		2	40

- Con condena y sin cilindro

## Opciones de cerradero

(ver páginas 42 - 48)

**PALANCA BASCULANTE ENTRE EJES 85 mm.**
**SERIE 196**

DESCRIPCIÓN	REF.	MEDIDAS		LEVA	ACABADOS		UDS	
		B	A		FRENTE	CILINDRO		
	196T23/6	20	33	13,25	AI	CN	1	20
	196T25/6	22	37	15	AI	CN	1	20
	196T28/6	25	38	13,25	AI	CN	1	20
	196T30/6	27	42	15	AI	CN	1	20
	196T33/6	30	43	13,25	AI	CN	1	20
	196T35/6	32	47	15	AI	CN	1	20
	196T38/6	35	48	13,25	AI	CN	1	20
		196T23/6AN	20	33	13,25	AI	CN	1
196T25/6AN		22	37	15	AI	CN	1	20
196T28/6AN		25	38	13,25	AI	CN	1	20
196T30/6AN		27	42	15	AI	CN	1	20
196T33/6AN		30	43	13,25	AI	CN	1	20
196T35/6AN		32	47	15	AI	CN	1	20
196T38/6AN		35	48	13,25	AI	CN	1	20
		196T25/6U	18	33	15	AI	CN	1
	196T30/6U	23	38	15	AI	CN	1	20
	196T35/6U	28	43	15	AI	CN	1	20

- Sólo picaporte y medio cilindro
- Cilindro 5982T40/4

**Opción cerradero eléctrico**

(ver página 49)

	196R23/6	20	33		AI	CN	1	20
	196R25/6	22	37		AI	CN	1	20
	196R28/6	25	38		AI	CN	1	20
	196R30/6	27	42		AI	CN	1	20
	196R33/6	30	43		AI	CN	1	20
	196R35/6	32	47		AI	CN	1	20
	196R38/6	35	48		AI	CN	1	20
		196R23/6AN	20	33		AI	CN	1
196R25/6AN		22	37		AI	CN	1	20
196R28/6AN		25	38		AI	CN	1	20
196R30/6AN		27	42		AI	CN	1	20
196R33/6AN		30	43		AI	CN	1	20
196R35/6AN		32	47		AI	CN	1	20
196R38/6AN		35	48		AI	CN	1	20
		196R25/6U	18	33		AI	CN	1
	196R30/6U	23	38		AI	CN	1	20
	196R35/6U	28	43		AI	CN	1	20



- Sólo picaporte y sin cilindro

**Opciones de cerradero**

(ver páginas 42 - 48)

## PALANCA BASCULANTE ENTRE EJES 85 mm.

## SERIE 196

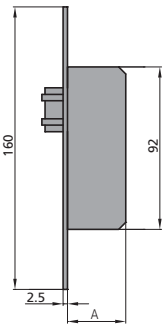
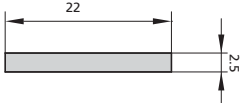
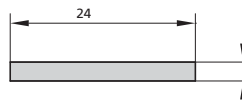
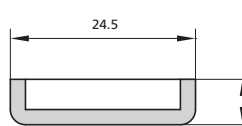
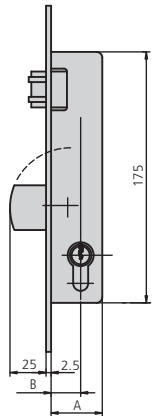
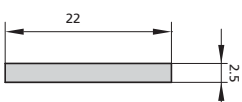
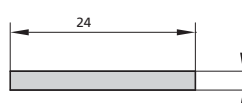
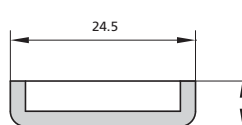
DESCRIPCIÓN	REF.	MEDIDAS		LEVA	ACABADOS		UDS	
		B	A		FRENTE	CILINDRO		
 <ul style="list-style-type: none"> <li>• Sólo vaivén</li> </ul> <p><b>Opciones de cerradero</b> (ver páginas 42 - 48)</p>								
	196RV/6		33		AI	CN	1	20
								
	196RV/6AN		33		AI	CN	1	20
								
	196RV/6U		33		AI	CN	1	20
 <ul style="list-style-type: none"> <li>• Rodillo vaivén regulable y palanca</li> <li>• Cilindro de leva larga 5982/2525/4 ó de leva corta 5990/2525/4</li> </ul> <p><b>Opciones de cerradero</b> (ver páginas 42 - 48)</p>								
	196V25/6	22	37	15	AI	CN	1	20
	196V28/6	25	38	13,25	AI	CN	1	20
	196V30/6	27	42	15	AI	CN	1	20
	196V33/6	30	43	13,25	AI	CN	1	20
	196V35/6	32	47	15	AI	CN	1	20
	196V38/6	35	48	13,25	AI	CN	1	20
								
	196V25/6AN	22	37	15	AI	CN	1	20
	196V28/6AN	25	38	13,25	AI	CN	1	20
196V30/6AN	27	42	15	AI	CN	1	20	
196V33/6AN	30	43	13,25	AI	CN	1	20	
196V35/6AN	32	47	15	AI	CN	1	20	
196V38/6AN	35	48	13,25	AI	CN	1	20	
								
196V25/6U	18	33	15	AI	CN	1	20	
196V30/6U	23	38	15	AI	CN	1	20	
196V35/6U	28	43	15	AI	CN	1	20	

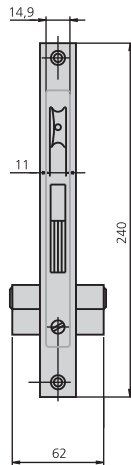
**PALANCA GANCHO ENTRE EJES 85 mm.**
**SERIE 197**

**CARACTERÍSTICAS**

- Frente inox de 22 mm
- Picaporte reversible de 11 mm
- Picaporte regulable excepto en entrada 25 mm y 28 mm
- Caja de 15 mm
- Cuadradillo de 8 mm
- 2 escudos de nylon ref. E51984
- 2 terminales de frente de nylon ref. EMB196 (para frente de 22 mm)
- Tornillo de fijación de cilindro

**ACCESORIOS OPCIONALES**

- Gama completa de cerraderos (ver páginas 42 - 48)
- Gama completa de cilindros (ver páginas 122 - 142)
- Escudo de seguridad pasante BTI296/1N (ver página 51)

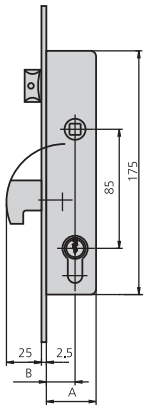
DESCRIPCIÓN	REF.	MEDIDAS		LEVA	ACABADOS		UDS	
		B	A		FRENTE	CILINDRO		



- Picaporte y palanca gancho
- Cilindro de leva larga 5982/2525/4 o de leva corta 5990/2525/4

**Opciones de cerradero**  
(ver páginas 42 - 48)

197/25/6	22	37	15	Al	CN	1	20
197/28/6	25	38	13,25	Al	CN	1	20
197/30/6	27	42	15	Al	CN	1	20
197/33/6	30	43	13,25	Al	CN	1	20
197/35/6	32	47	15	Al	CN	1	20
197/38/6	35	48	13,25	Al	CN	1	20

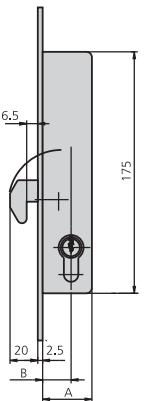

- Cerradura para puerta corredera
- Sólo palanca gancho
- Cilindro de leva larga 5982/2525/4 o de leva corta 5990/2525/4

**Opciones de cerradero**  
(ver páginas 42 - 48)

197K25/6	22	37	15	Al	CN	1	20
197K28/6	25	38	13,25	Al	CN	1	20
197K30/6	27	42	15	Al	CN	1	20
197K33/6	30	43	13,25	Al	CN	1	20
197K35/6	32	47	15	Al	CN	1	20
197K38/6	35	48	13,25	Al	CN	1	20

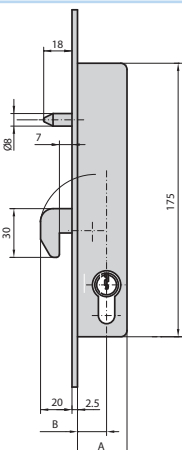

- Cerradura para puerta corredera
- Sólo palanca gancho con pin de seguridad
- Cilindro de leva larga 5982/2525/4

197KB25/6	22	37	15	Al	CN	1	20
197KB30/6	27	42	15	Al	CN	1	20
197KB35/6	32	47	15	Al	CN	1	20



**MULTIPUNTO PALANCA BASCULANTE ENTRE EJES 85 mm.**
**SERIE 296**

DESCRIPCIÓN	REF.	MEDIDAS		LEVA	ACABADOS		UDS
		B	A		FRENTE	CILINDRO	
	296A25/6L	22	37	15	Al		1
	296A28/6L	25	38	13,25	Al		1
	296A30/6L	27	42	15	Al		1
	296A33/6L	30	43	13,25	Al		1
	296A35/6L	32	47	15	Al		1
	296A38/6L	35	48	13,25	Al		1
	296A25/6LAN	22	37	15	Al		1
	296A28/6LAN	25	38	13,25	Al		1
	296A30/6LAN	27	42	15	Al		1
	296A33/6LAN	30	43	13,25	Al		1
	296A35/6LAN	32	47	15	Al		1
	296A38/6LAN	35	48	13,25	Al		1
	296A25/6U	18	33	15	Al		1
	296A30/6U	23	38	15	Al		1
	296A35/6U	28	43	15	Al		1

• Sólo palanca  
 • Cilindro no incluido  
**Opciones de cerradero**  
 (ver páginas 42 - 48)

	296V25/6L	22	37	15	Al		1
	296V28/6L	25	38	13,25	Al		1
	296V30/6L	27	42	15	Al		1
	296V33/6L	30	43	13,25	Al		1
	296V35/6L	32	47	15	Al		1
	296V38/6L	35	48	13,25	Al		1
	296V25/6LAN	22	37	15	Al		1
	296V28/6LAN	25	38	13,25	Al		1
	296V30/6LAN	27	42	15	Al		1
	296V33/6LAN	30	43	13,25	Al		1
	296V35/6LAN	32	47	15	Al		1
	296V38/6LAN	35	48	13,25	Al		1
	296V25/6U	18	33	15	Al		1
	296V30/6U	23	38	15	Al		1
	296V35/6U	28	43	15	Al		1

• Rodillo vaivén regulable y palanca  
 • Cilindro no incluido  
**Opciones de cerradero**  
 (ver páginas 42 - 48)



## MULTIPUNTO PALANCA BASCULANTE ENTRE EJES 85 mm.

## SERIES 396

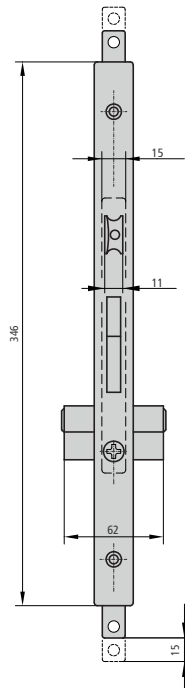

## CARACTERÍSTICAS

- Cerradura de 3 puntos central y alto/bajo mediante llave
- Frente liso inox de 22 mm y U 24,5\*6 mm
- Frente de 346 mm de largo
- Picaporte de 11 mm reversible y regulable
- Caja de 15 mm
- Cuadradillo de 8 mm
- 2 escudos de nylon ref. E51984
- Tornillo de fijación de cilindro

## ACCESORIOS OPCIONALES

- Gama completa de cerraderos (ver páginas 42 - 48)
- Gama completa de cilindros (ver páginas 122 - 142)
- Poliamida POLCE (ver página 51)

## DESCRIPCIÓN

## REF.

## MEDIDAS

## LEVA

## ACABADOS

## UDS

B

A

FRENTE

CILINDRO



- Picaporte y palanca
- Cilindro no incluido

**Opciones de cerraderos**  
(ver páginas 42 - 48)

**Opción de cerradero eléctrico**  
(ver página 49)

396/25/6L	22	37	15	Al	1	10
396/28/6L	25	38	13,25	Al	1	10
396/30/6L	27	42	15	Al	1	10
396/33/6L	30	43	13,25	Al	1	10
396/35/6L	32	47	15	Al	1	10
396/38/6L	35	48	13,25	Al	1	10

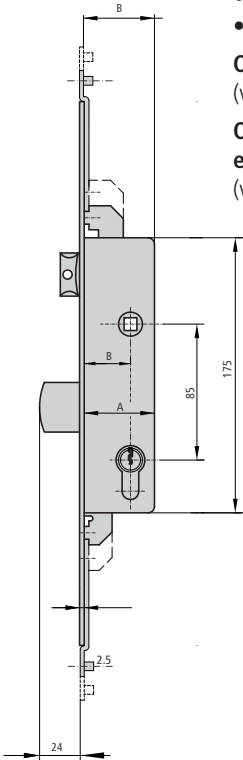

**MULTIPUNTO PALANCA GANCHO ENTRE EJES 85 mm.**

**SERIE 297K**

**CARACTERÍSTICAS**

- Para puertas correderas
- Frente inox U de 1850x16x6 mm
- Caja de 15 mm
- Cuadradillo de 8 mm
- Tornillo de fijación de cilindro

**ACCESORIOS OPCIONALES**

- Gama completa de cilindros (ver páginas 122 - 142)

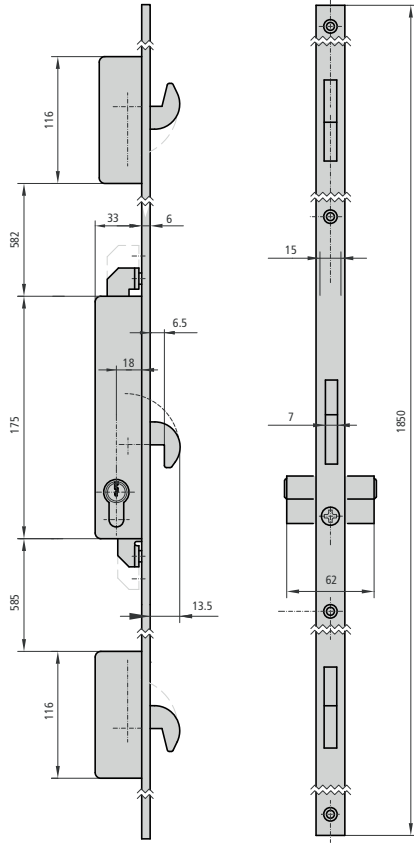

**DESCRIPCIÓN**

REF.

MEDIDAS  
B A

LEVA

ACABADOS  
FRENTE CILINDRO

UDS



297K25/6U16

18

33

15

Al

1

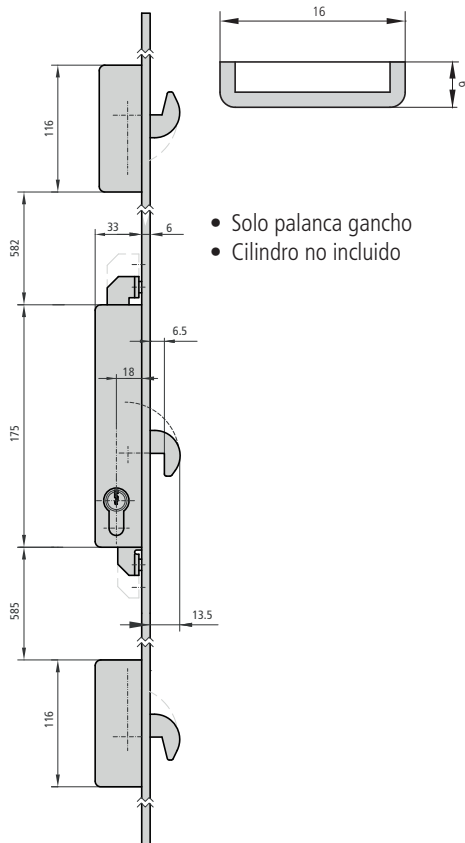

- Solo palanca gancho
- Cilindro no incluido

## PALANCA DESLIZANTE ENTRE EJES 92 mm.

## SERIE 192

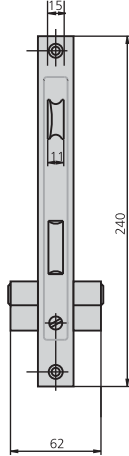

## CARACTERÍSTICAS

- Frente inox de 16 mm, 22 mm o 24 mm
- Picaporte reversible de 11 mm
- Caja de 15 mm
- Cuadradillo de 8 mm
- 2 escudos de nylon ref. ES1984
- 2 terminales de frente de nylon ref. EMB196 para frente liso (para frente de 22 mm)
- Tornillo de fijación de cilindro

## ACCESORIOS OPCIONALES

- Gama completa de cerraderos (ver páginas 42 - 48)
- Gama completa de cilindros (ver páginas 122 - 142)

## DESCRIPCIÓN

## REF.

## MEDIDAS

## LEVA

## ACABADOS

## UDS

B

A

FRENTE

CILINDRO

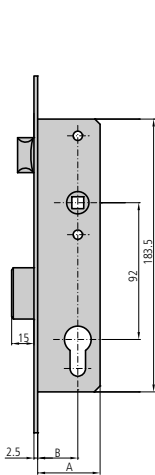

- Picaporte y palanca
- Cilindro europerfil leva DIN

**Opciones de cerradero**  
(ver páginas 42 - 48)

**Opción de cerradero eléctrico**  
(ver página 49)

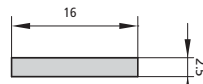

P192/25/6	22	37	15	Al	CN	1	20
P192/30/6	27	42	15	Al	CN	1	20
P192/35/6	32	47	15	Al	CN	1	20

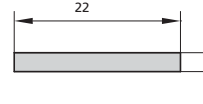

192/25/6	22	37	15	Al	CN	1	20
192/30/6	27	42	15	Al	CN	1	20
192/35/6	32	47	15	Al	CN	1	20

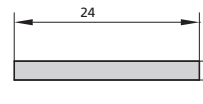

192/25/6AN	22	37	15	Al	CN	1	20
192/30/6AN	27	42	15	Al	CN	1	20
192/35/6AN	32	47	15	Al	CN	1	20

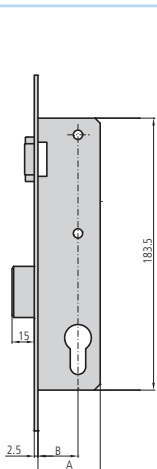

- Rodillo vaivén regulable y palanca
- Cilindro europerfil leva DIN

**Opciones de cerradero**  
(ver páginas 42 - 48)

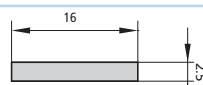

P192V25/6	22	37	15	Al	CN	1	20
P192V30/6	27	42	15	Al	CN	1	20
P192V35/6	32	47	15	Al	CN	1	20

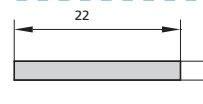

192V25/6	22	37	15	Al	CN	1	20
192V30/6	27	42	15	Al	CN	1	20
192V35/6	32	47	15	Al	CN	1	20

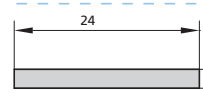

192V25/6AN	22	37	15	Al	CN	1	20
192V30/6AN	27	42	15	Al	CN	1	20
192V35/6AN	32	47	15	Al	CN	1	20



**CERRADURA CORTAFUEGO PALANCA DESLIZANTE ENTRE EJES 92mm.**

**SERIE F192**

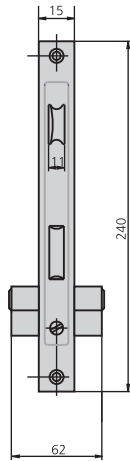

**CARACTERÍSTICAS**

- Cerradura cortafuego
- Frente inox de 16, 22 o 24 mm
- Picaporte reversible de hierro de 11 mm
- Caja de 15 mm
- Cuadradillo de 8 mm
- 2 escudos de nylon ref. ES1984
- 2 terminales de frente de nylon ref. EMB196 para frente liso (para frente de 22 mm)
- Tornillo de fijación de cilindro

**ACCESORIOS OPCIONALES**

- Gama completa de cerraderos (ver páginas 42 - 48)
- Gama completa de cilindros (ver páginas 122 - 142)

DESCRIPCIÓN	REF.	MEDIDAS		LEVA	ACABADOS		UDS	
		B	A		FRENTE	CILINDRO		

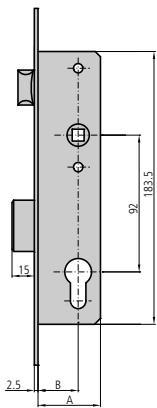

- Picaporte y palanca
- Cilindro no incluido

**Opciones de cerradero**  
(ver páginas 42 - 48)

**Opción de cerradero eléctrico**  
(ver página 49)

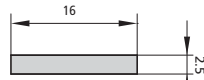

FP192/25/6	22	37	15	AI	1	20
FP192/30/6	27	42	15	AI	1	20
FP192/35/6	32	47	15	AI	1	20

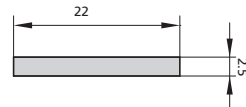

F192/25/6	22	37	15	AI	1	20
F192/30/6	27	42	15	AI	1	20
F192/35/6	32	47	15	AI	1	20

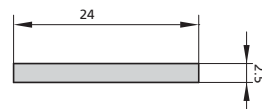

F192/25/6AN	22	37	15	AI	1	20
F192/30/6AN	27	42	15	AI	1	20
F192/35/6AN	32	47	15	AI	1	20

## PALANCA BASCULANTE ENTRE EJES 92 mm.

## SERIE 194

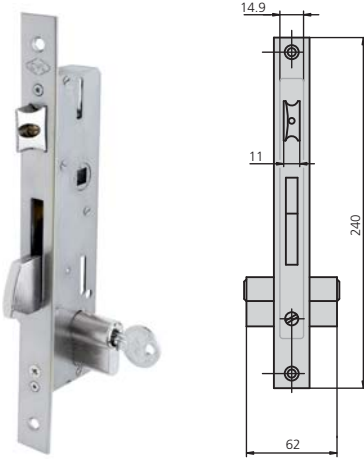

## CARACTERÍSTICAS

- Frente liso inox de 22 mm o 24 mm ó frente inox en U de 24,5x6
- Picaporte reversible de 11 mm
- Picaporte regulable excepto en entrada 25 mm
- Caja de 15 mm
- Cuadradillo de 8 mm
- 2 escudos de nylon ref. ES1984
- 2 terminales de frente de nylon ref. EMB196 para frente liso (para frente de 22 mm)
- Tornillo de fijación de cilindro

## ACCESORIOS OPCIONALES

- Gama completa de cerraderos (ver páginas 42 - 48)
- Gama completa de cilindros (ver páginas 122 - 142)
- Escudo de seguridad pasante BTI296 (ver página 51)

## DESCRIPCIÓN

## REF.

## MEDIDAS

## LEVA

## ACABADOS

## UDS

B

A

FRENTE

CILINDRO

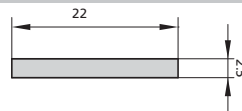
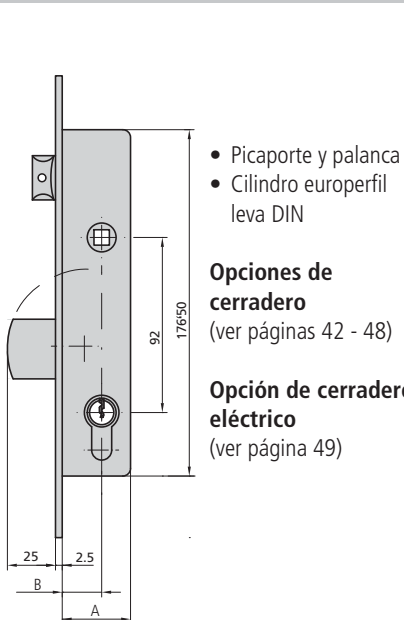

194/25/6	22	37	15	AI	CN	1	20
194/30/6	27	42	15	AI	CN	1	20
194/35/6	32	47	15	AI	CN	1	20

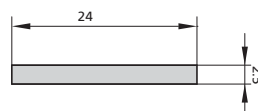

194/25/6AN	22	37	15	AI	CN	1	20
194/30/6AN	27	42	15	AI	CN	1	20
194/35/6AN	32	47	15	AI	CN	1	20

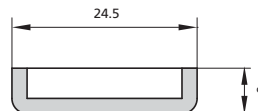

194/25/6U	18	33	15	AI U	CN	1	20
194/30/6U	23	38	15	AI U	CN	1	20
194/35/6U	28	43	15	AI U	CN	1	20

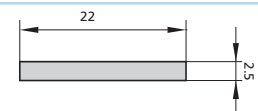
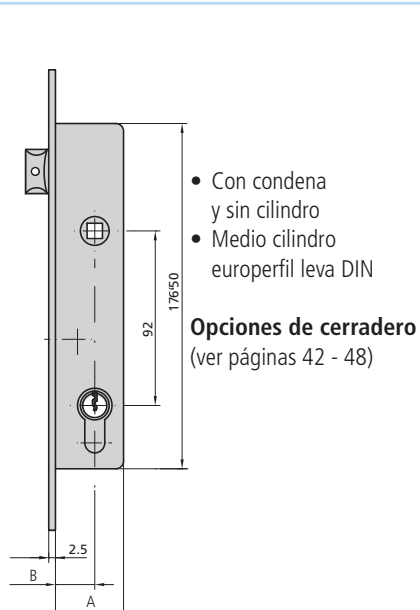

194T25/6	22	37	15	AI	CN	1	20
194T30/6	27	42	15	AI	CN	1	20
194T35/6	32	47	15	AI	CN	1	20

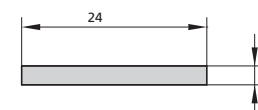

194T25/6AN	22	37	15	AI	CN	1	20
194T30/6AN	27	42	15	AI	CN	1	20
194T35/6AN	32	47	15	AI	CN	1	20

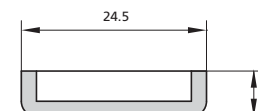

194T25/6U	18	33	15	AI U	CN	1	20
194T30/6U	23	38	15	AI U	CN	1	20
194T35/6U	28	43	15	AI U	CN	1	20

**PALANCA BASCULANTE ENTRE EJES 92 mm.**
**SERIE 194**

DESCRIPCIÓN	REF.	MEDIDAS		LEVA	ACABADOS		UDS	
		B	A		FRENTE	CILINDRO		
<ul style="list-style-type: none"> <li>Rodillo vaivén regulable y palanca.</li> <li>Cilindro europerfil leva DIN</li> </ul> <p><b>Opciones de cerradero</b> (ver páginas 42 - 48)</p>								
	194V25/6	22	37	15	AI	CN	1	20
	194V30/6	27	42	15	AI	CN	1	20
	194V35/6	32	47	15	AI	CN	1	20
	194V25/6AN	22	37	15	AI	CN	1	20
	194V30/6AN	27	42	15	AI	CN	1	20
	194V35/6AN	32	47	15	AI	CN	1	20
	194V25/6U	18	33	15	AI U	CN	1	20
	194V30/6U	23	38	15	AI U	CN	1	20
	194V35/6U	28	43	15	AI U	CN	1	20



## MULTIPUNTO PALANCA BASCULANTE ENTRE EJES 92 mm.

## SERIE 294

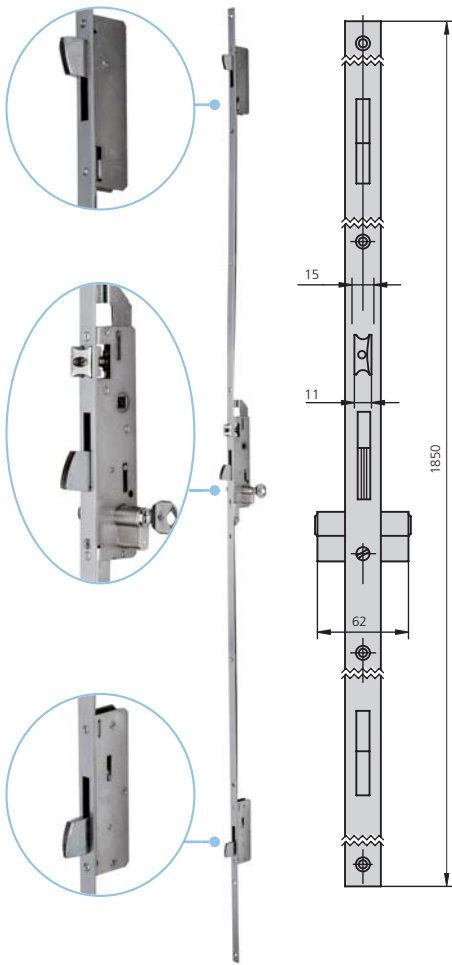

## CARACTERÍSTICAS

- Frente liso inox de 1850x22 mm o 1850x24 mm o frente U de 1850x24,5x6
- Picaporte reversible de 11 mm
- Picaporte regulable excepto en entrada 25 mm
- Caja de 15 mm
- Cuadradillo de 8 mm
- Escudo de seguridad pasante ref. BTI296/1N
- Tornillo de fijación de cilindro

## ACCESORIOS OPCIONALES

- Gama completa de cerraderos (ver páginas 42 - 48)
- Gama completa de cilindros (ver páginas 122 - 142)
- Frente de 2300 mm de largo opcional (serie 494)
- Frente de 1500 mm de largo opcional (serie 594)

## DESCRIPCIÓN

## REF.

## MEDIDAS

## LEVA

## ACABADOS

## UDS

B

A

FRENTE

CILINDRO

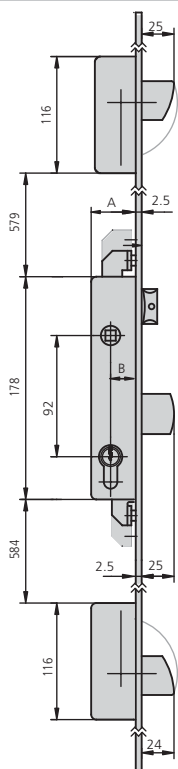

- Picaporte y palanca
- Cilindro no incluido

**Opciones de cerradero**  
(ver páginas 42 - 48)

**Opción cerradero eléctrico**  
(ver página 49)

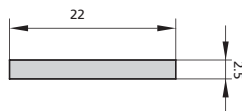

294/25/6L	22	37	15	Al	1
294/30/6L	27	42	15	Al	1
294/35/6L	32	47	15	Al	1

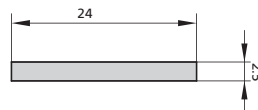

294/25/6LAN	22	37	15	Al	1
294/30/6LAN	27	42	15	Al	1
294/35/6LAN	32	47	15	Al	1

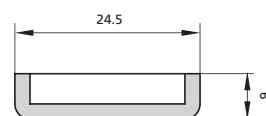

294/25/6U	18	33	15	Al	1
294/30/6U	23	38	15	Al	1
294/35/6U	28	43	15	Al	1

**MULTIPUNTO PALANCA BASCULANTE ENTRE EJES 92 mm.**
**SERIE 294**

DESCRIPCIÓN	REF.	MEDIDAS		LEVA	ACABADOS		UDS	
		B	A		FRENTE	CILINDRO		
<ul style="list-style-type: none"> <li>• Solo palanca</li> <li>• Cilindro no incluido</li> </ul> <p><b>Opciones de cerradero</b> (ver páginas 42 - 48)</p>								

<ul style="list-style-type: none"> <li>• Rodillo vaivén regulable y palanca</li> <li>• Cilindro no incluido</li> </ul> <p><b>Opciones de cerradero</b> (ver páginas 42 - 48)</p>								

**ACCESORIOS** **CERRADEROS**

DESCRIPCIÓN	REF.	APLICABLE A CERRADURAS	UDS  
-------------	------	------------------------	---

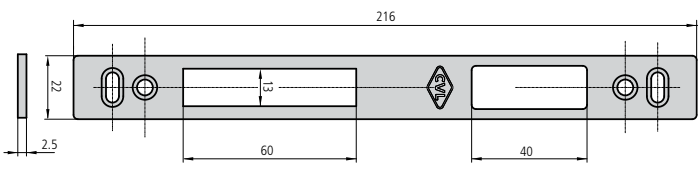

- Cerradero fijo de hierro niquelado CE184/0L
- Cerradero fijo de acero inoxidable CE184/6L

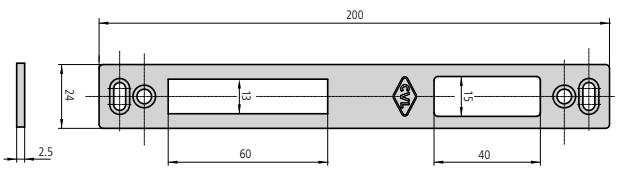

- Cerradero fijo de hierro niquelado CE184/0LAN
- Cerradero fijo de acero inoxidable CE184/6LAN

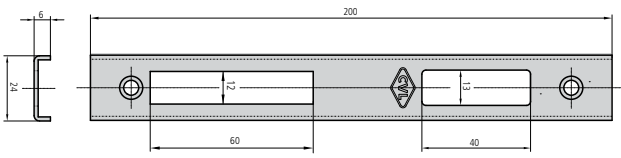

- Cerradero fijo de acero inoxidable CE184/6U

184, 184C, 184V, 192, 192C, 192V, F192, 1E5, central 2E5, 1E2, central 2E2, 615, 615E

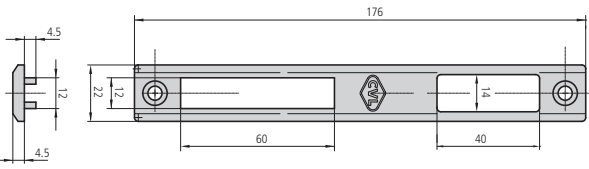

- Cerradero fijo metálico negro CE184/1N

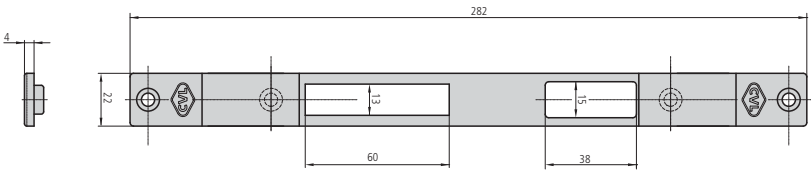

- Cerradero regulable metálico negro CE184/1NR

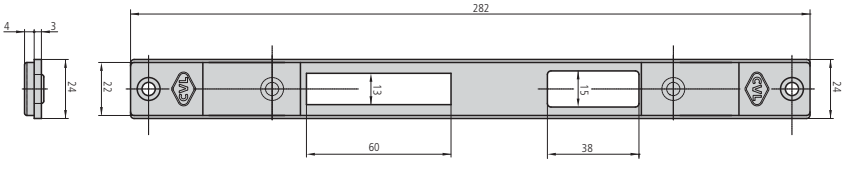

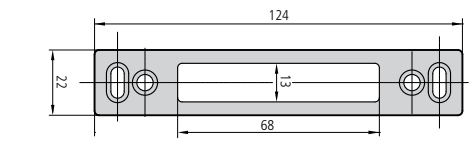

- Cerradero regulable metálico negro con suplemento CE184/1NRS



184A

- Cerradero fijo de hierro niquelado CE184A/0L
- Cerradero fijo de acero inoxidable CE184A/6L

**ACCESORIOS**
**CERRADEROS**

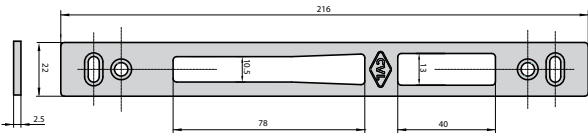
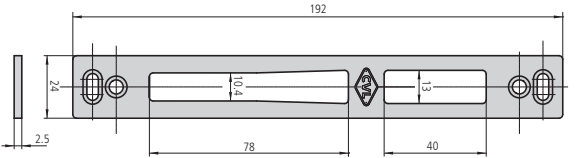
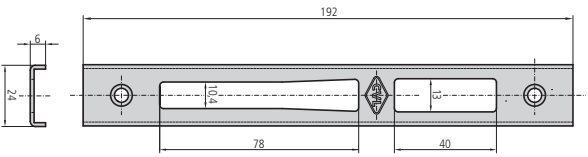
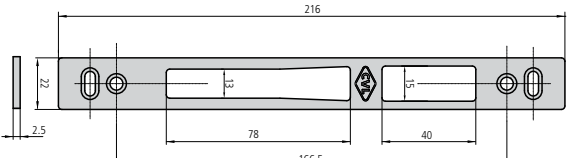
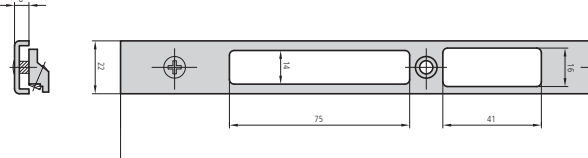
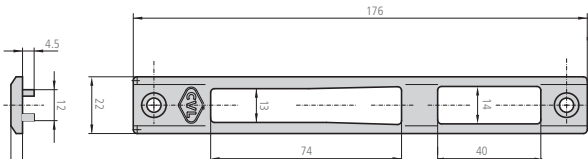
DESCRIPCIÓN	REF.	APLICABLE A CERRADURAS	UDS  
	CE196/6L		
	CE196/6LAN		
	CE196/6U	196, 196C, 196V, 197, 194, 194C, 194V, central 296, 296V, 396, 496, 496V, 596, 596V, 294, 294V, 494, 494V	
	CE196/6LR		
	CE196/6RU		
	CE196/1N		

**ACCESORIOS** **CERRADEROS**

DESCRIPCIÓN	REF.	APLICABLE A CERRADURAS	UDS
-------------	------	------------------------	-----

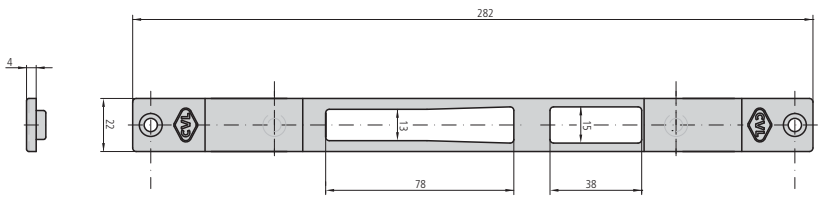

• Cerradero regulable metálico negro CE196/1NR

196, 196C, 196V, 197,  
194, 194C, 194V,  
central 296, 296V, 396 496,  
496V, 596, 596V,  
294, 294V, 494, 494V

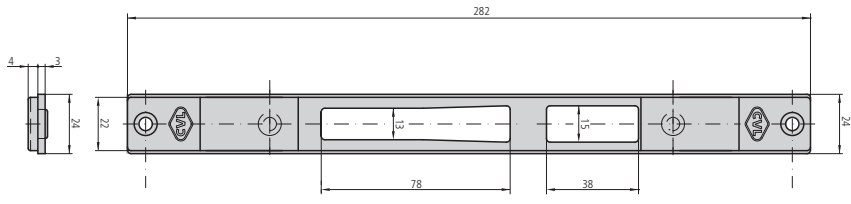

• Cerradero regulable metálico negro con suplemento CE196/1NRS

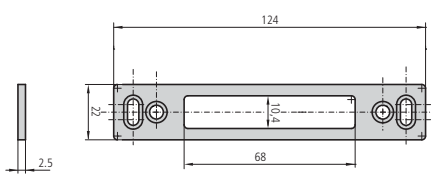

• Cerradero fijo de acero inoxidable para solo palanca CE296S/6L

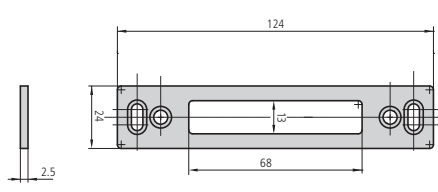

• Cerradero fijo de acero inoxidable para solo palanca CE296S/6LAN

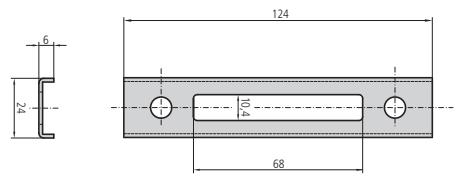

196A, 197K, 296A, 496A, 596A,  
294A, 494A, suplementos alto/bajo  
de las series 296, 496, 596, 294,  
494, 2E5, 2E2, 2K2, 2K5

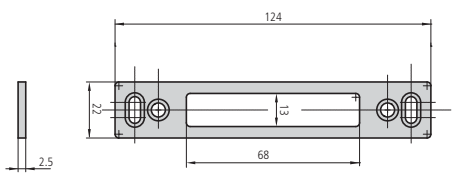

• Cerradero fijo de acero inoxidable para solo palanca CE296S/6U

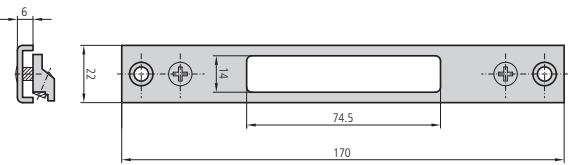
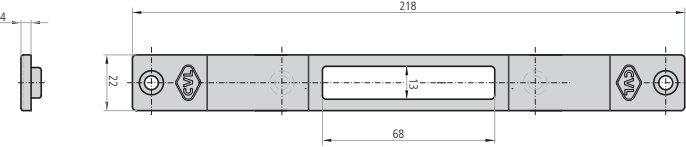
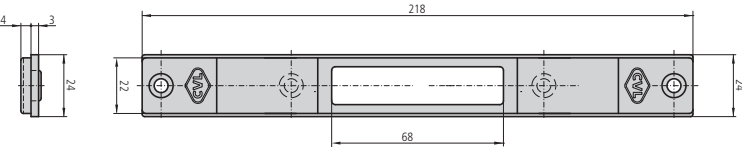
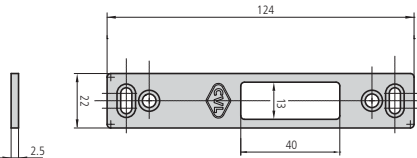
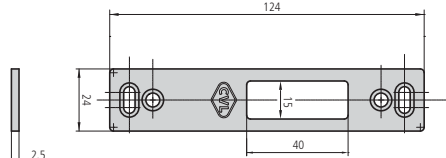
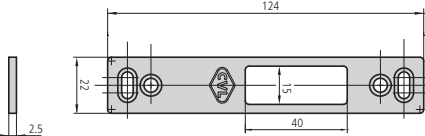

• Cerradero regulable de acero inoxidable con levas CE296S/6LR

DESCRIPCIÓN	REF.	APLICABLE A CERRADURAS	UDS  
	CE296S/6RU		
<ul style="list-style-type: none"> <li>• Cerradero regulable inox en U solo palanca</li> </ul>			
	CE296S/1NR	196A, 197K, 296A, 496A, 596A, 294A, 494A, suplementos alto/bajo de las series 296, 496, 596, 294, 494, 2E5, 2E2, 2K2 2K5	
<ul style="list-style-type: none"> <li>• Cerradero regulable metálico negro</li> </ul>			
	CE296S/1NRS		
<ul style="list-style-type: none"> <li>• Cerradero regulable metálico negro con suplemento</li> </ul>			
	CE196R/6L		
<ul style="list-style-type: none"> <li>• Cerradero fijo de acero inoxidable para solo picaporte</li> </ul>			
	CE196R/6LAN	196R, 196RV, 196T, 194T	
<ul style="list-style-type: none"> <li>• Cerradero fijo de acero inoxidable para solo picaporte</li> </ul>			
	CE196R/6LR		
<ul style="list-style-type: none"> <li>• Cerradero regulable de acero inoxidable con levas</li> </ul>			



**ACCESORIOS** **CERRADEROS**

DESCRIPCIÓN	REF.	APLICABLE A CERRADURAS	UDS 
-------------	------	------------------------	---

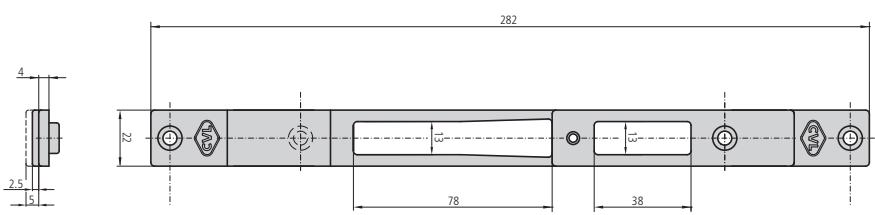

- Cerradero regulable metálico negro, incluye 1 suplemento de 2,5 mm y otro de 5 mm **KCE1K5/1NR** 1K2, 1K5, central 2K2, central 2K5

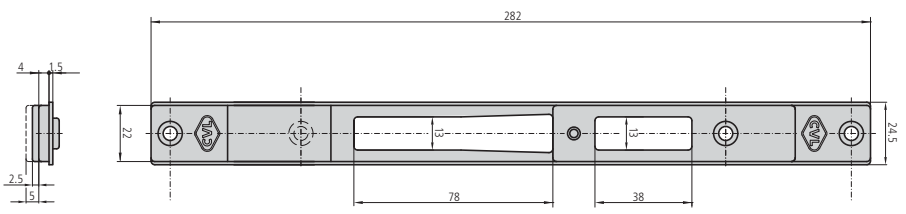

- Cerradero regulable metálico negro con suplemento, incluye 1 suplemento de 2,5 mm y otro de 5 mm **KCE1K5/1NRS** 1K2, 1K5, central 2K2, central 2K5

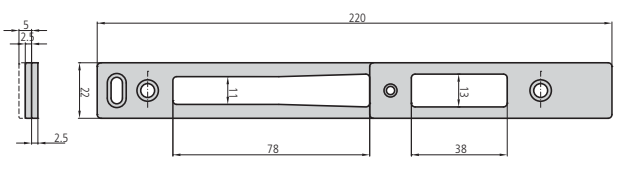

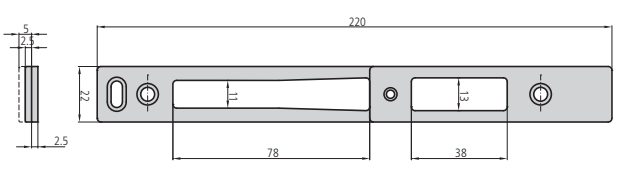

- Cerradero fijo de acero inoxidable de 22 mm, incluye 1 suplemento de 2,5 mm y otro de 5 mm **KCE1K5/6L** 1K2, 1K5, central 2K2, central 2K5



- Cerradero regulable de acero inoxidable, incluye 1 suplemento de 2,5 mm y otro de 5 mm con levas **KCE1K5/6LR** 1K2, 1K5, central 2K2, central 2K5

## ACCESORIOS

## CERRADEROS

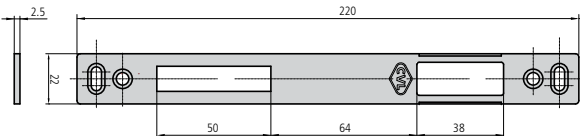
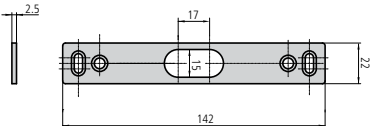
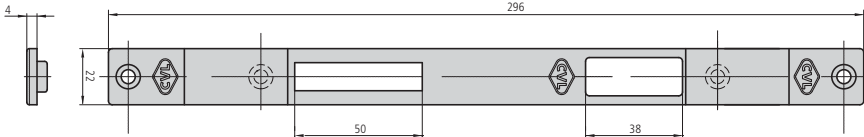
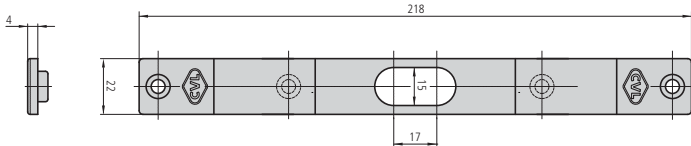
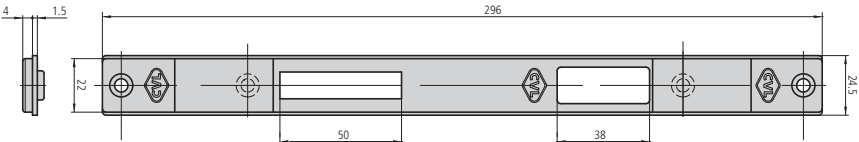
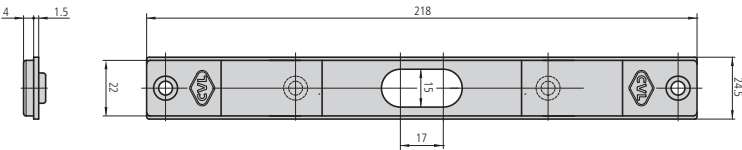
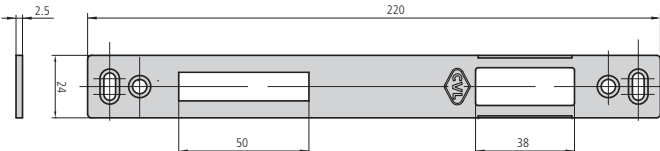
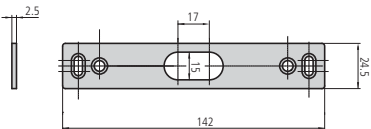
DESCRIPCIÓN	REF.	APLICABLE A CERRADURAS	UDS  
	CE202/6L	central 202, 302	---
<ul style="list-style-type: none"> <li>Cerradero fijo de acero inoxidable</li> </ul>			
	CE202S/6L	alto / bajo 202	---
<ul style="list-style-type: none"> <li>Cerradero fijo de acero inoxidable</li> </ul>			
	CE202/1NR	central 202, 302	---
<ul style="list-style-type: none"> <li>Cerradero regulable metálico negro</li> </ul>			
	CE202S/1NR	alto / bajo 202	---
<ul style="list-style-type: none"> <li>Cerradero regulable metálico negro</li> </ul>			
	CE202/1NRS	central 202, 302	---
<ul style="list-style-type: none"> <li>Cerradero regulable metálico negro con suplemento</li> </ul>			
	CE202S/1NRS	alto / bajo 202	---
<ul style="list-style-type: none"> <li>Cerradero regulable metálico negro con suplemento</li> </ul>			
	CE202/6LAN	central 202, 302	---
<ul style="list-style-type: none"> <li>Cerradero fijo de acero inoxidable de 24 mm</li> </ul>			
	CE202S/6LAN	alto / bajo 202	---
<ul style="list-style-type: none"> <li>Cerradero fijo de acero inoxidable de 24 mm</li> </ul>			

**ACCESORIOS** **CERRADEROS**

DESCRIPCIÓN	REF.	APLICABLE A CERRADURAS	UDS  
-------------	------	------------------------	---

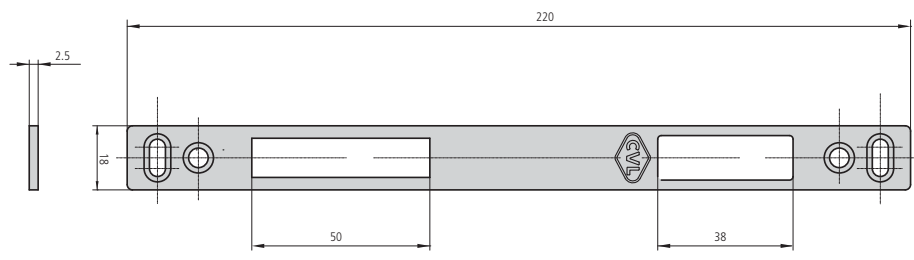

• Cerradero regulable de acero inoxidable con levas    CE202/6LR18    central 202, 302    -----

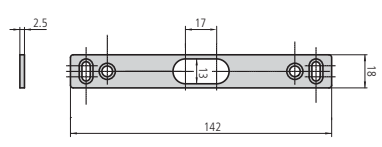

• Cerradero regulable de acero inoxidable con levas    CE202S/6LR18    alto / bajo 202    -----

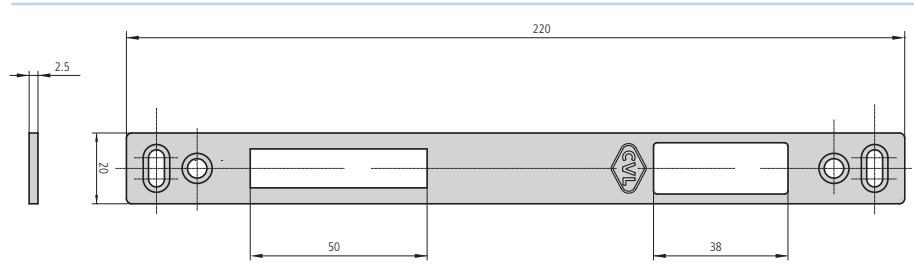

• Cerradero regulable de acero inoxidable con levas    CE202/6LR20    central 202, 302    -----

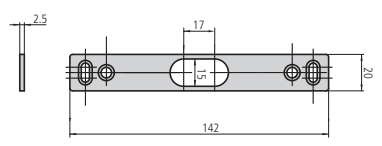

• Cerradero regulable de acero inoxidable con levas    CE202S/6LR20    alto / bajo 202    -----

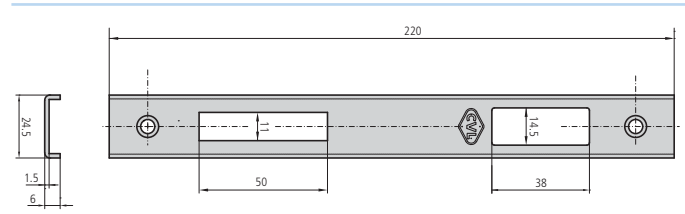

• Cerradero fijo de acero inoxidable    CE202/6U    central 202, 302    -----

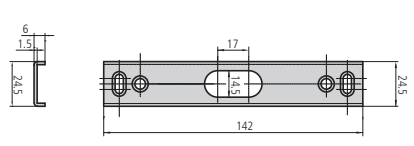

• Cerradero fijo de acero inoxidable    CE202S/6U    alto / bajo 202    -----

**ACCESORIOS**
**CERRADEROS ELÉCTRICOS**

DESCRIPCIÓN	REF.	APLICABLE A CERRADURAS	UDS 
<ul style="list-style-type: none"> <li>• Cerradero eléctrico regulable reversible con funcionamiento automático</li> <li>• Frente plano inox</li> </ul>	CEC41/6A	184, 196, 197, 296, 396, 496, 596, 192, F192, 194, 294, 494, 183, 612, 612E, 615E, 615	
			
<ul style="list-style-type: none"> <li>• Cerradero eléctrico regulable reversible con funcionamiento automático y con desbloqueo</li> <li>• Frente plano inox</li> </ul>	CEC41/6AD	184, 196, 197, 296, 396, 496, 596, 192, F192, 194, 294, 494, 183, 612, 612E, 615E, 615	
			
<ul style="list-style-type: none"> <li>• Cerradero eléctrico regulable reversible con funcionamiento automático</li> <li>• Sólo picaporte y frente plano inox</li> </ul>	CEC41T/6A	196T, 194T, 183T	
			
<ul style="list-style-type: none"> <li>• Cerradero eléctrico regulable reversible con funcionamiento automático y con desbloqueo</li> <li>• Sólo picaporte y frente plano inox</li> </ul>	CEC41T/6AD	196T, 194T, 183T	
			

**ACCESORIOS** **ESCUDOS Y MANILLAS DE ACERO INOXIDABLE**

DESCRIPCIÓN	REF.	ACABADO	CANTO SERIES	UDS
-------------	------	---------	--------------	-----

<ul style="list-style-type: none"> <li>• Escudo con manilla y bocallave cilindro para aluminio</li> <li>• Entre ejes 85 mm</li> <li>• No incluye cilindro</li> </ul> 	<p>JM6006/85/6R</p>	<p>Al</p>	<p>Red.</p>	<p>2</p>
--	---------------------	-----------	-------------	----------



<ul style="list-style-type: none"> <li>• Roseta para aluminio</li> </ul> 	<p>JM6000/6R</p>	<p>Al</p>	<p>Red.</p>	<p>2</p>
---	------------------	-----------	-------------	----------

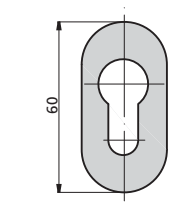

<ul style="list-style-type: none"> <li>• Escudo para cilindro</li> </ul> 	<p>JES6000/6R</p>	<p>Al</p>	<p>Red.</p>	<p>2</p>
--	-------------------	-----------	-------------	----------



<ul style="list-style-type: none"> <li>• Placa con tirador y bocallave de cilindro</li> <li>• No incluye cilindro</li> </ul> 	<p>JT6006/85/6R</p>	<p>Al</p>	<p>Red.</p>	<p>2</p>
--	---------------------	-----------	-------------	----------



**ACCESORIOS**
**ESCUDOS**

DESCRIPCIÓN	REF.	ACABADO	CANTO SERIES	UDS
<ul style="list-style-type: none"> <li>Escudo de seguridad no pasante, 1 escudo de nylon y 2 tornillos</li> </ul>	BTI94/1N BTI94/1NM BTI94/1PL	NEGRO NÍQUEL MATE PLATA		
	NEGRO NÍQUEL MATE PLATA			
<ul style="list-style-type: none"> <li>Escudo de seguridad pasante con contraescudo, capucha de nylon y dos tornillos pasantes</li> </ul>	BTI296/1N BTI296/1NM BTI296/1PL	NEGRO NÍQUEL MATE PLATA		
	NEGRO NÍQUEL MATE PLATA			
<ul style="list-style-type: none"> <li>Escudo de nylon</li> </ul>	ES1984	NEGRO		

**ACCESORIOS**
**OTROS**

DESCRIPCIÓN	REF.	APLICABLE A SERIES	UDS
<ul style="list-style-type: none"> <li>Terminales de nylon</li> </ul>	EMB196	184, 192, 196, 197, 194, 1E5, 1E2, 1K5	10
<ul style="list-style-type: none"> <li>Conjunto vaivén para la serie SOFT</li> </ul>	CV1E5	1E5, 2E5, 1E2, 2E2	10
<ul style="list-style-type: none"> <li>Tapa resbalón para la serie SOFT</li> </ul>	TAP1E5	1E5, 2E5, 1E2, 2E2	10
<ul style="list-style-type: none"> <li>Poliamida extrudida para perfiles de Cámara Europea</li> </ul>	POLCE-CVL	302, 396	100 m





## CERRADURAS DE EMBUTIR PARA CARPINTERÍA METÁLICA



Palanca deslizante entre ejes 85 cilindro europerfil leva corta	54
• Serie 1984	54
Palanca deslizante entre ejes 85 cilindro europerfil leva larga	56
• Serie 1995	56
Palanca gancho entre ejes 85 cilindro europerfil	58
• Serie 190	58
• Serie 1990	59
• Serie 1994	60
Multipunto palanca gancho entre ejes 85	62
• Serie 2994	62
Multipunto palanca gancho entre ejes 85	64
• Serie 3994	64
Palanca deslizante entre ejes 92 cilindro europerfil	66
• Serie 1992	66
Palanca deslizante entre ejes 70 cilindro europerfil	67
• Serie 1983	67
Palanca deslizante entre ejes 85 cilindro ovalado monoblock	69
• Serie 1963	69
• Serie 1975	71
Palanca deslizante entre ejes 74 cilindro ovalado de vástagos	72
• Serie 1964	72
Cerradura para puertas de zócalo con cilindro ovalado de vástagos	74
• Serie 1981	74
Cerradura para puertas de zócalo con cilindro europerfil	75
• Serie 1991	75
Cerradura de sólo gancho con cilindro ovalado de vástagos	76
• Serie 1968	76
Cerradura de sólo gancho con cilindro europerfil	77
• Serie 1982	77
Cerradura de sólo picaporte para puertas metálicas	78
• Serie 1979	78
Cerradura para puertas y persianas metálicas enrollables	79
• Serie 11A	79
• Serie 11E	80
Cerradura para puertas metálicas basculantes	81
• Serie 11B	81
Accesorios	82
• Cerraderos para cerraduras metálicas	82
• Cerraderos eléctricos	85
• Escudos	86
• Escudos de seguridad	86

**PALANCA DESLIZANTE ENTRE EJES 85 CILINDRO EUROPERFIL LEVA CORTA**

**SERIE 1984**

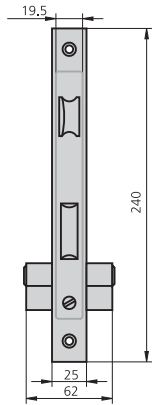

**CARACTERÍSTICAS**

- Frente hierro niquelado ó acero inoxidable
- Caja bicromatada
- Palanca deslizante
- Picaporte reversible
- Cuadradillo de 8 mm
- Cilindro europerfil
- 2 escudos de nylon ref. ES1984
- Tornillo de fijación de cilindro

**ACCESORIOS OPCIONALES**

- Cerraderos según cerradura (ver abajo)
- Gama completa de cilindros (ver páginas 122 - 142)

DESCRIPCIÓN	REF.	MEDIDAS		LEVA	ACABADOS		UDS	
		B	A		FRENTE	CILINDRO		

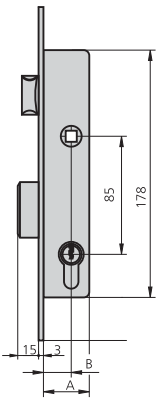

- Picaporte y palanca
- Cilindro 5990/2525

**Opciones de cerradero**

- CE1984/0 o CE1984/6

**Opción cerraderos eléctricos**

- CEC45/6A
- CEC45/6AD

1984/20/0	20	33	13,25	HN	CN	1	20
1984/20/5	20	33	13,25	HN	CL	1	20
1984/20/6	20	33	13,25	AI	CN	1	20
1984/25/0	25	38	13,25	HN	CN	1	20
1984/25/5	25	38	13,25	HN	CL	1	20
1984/25/6	25	38	13,25	AI	CN	1	20
1984/30/0	30	43	13,25	HN	CN	1	20
1984/30/5	30	43	13,25	HN	CL	1	20
1984/30/6	30	43	13,25	AI	CN	1	20

- Cerradura de condena
- Sin cilindro

1984C20/6	20	33		AI		2	40
1984C25/6	25	38		AI		2	40
1984C30/6	30	43		AI		2	40

**Opciones de cerradero**

- CE1984/6

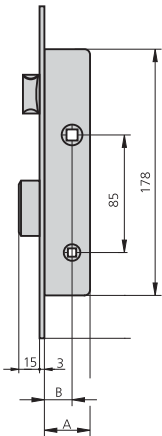

DESCRIPCIÓN	REF.	MEDIDAS		LEVA	ACABADOS		UDS	
		B	A		FRENTE	CILINDRO		

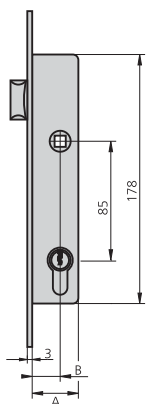

- Sólo picaporte
- Cilindro 5982T40/4

1984T20/6	20	33	15	Al	CN	1	20
1984T25/6	25	38	15	Al	CN	1	20
1984T30/6	30	43	15	Al	CN	1	20

**Opción cerraderos eléctricos**

- CEC45/6A o CEC45/6AD

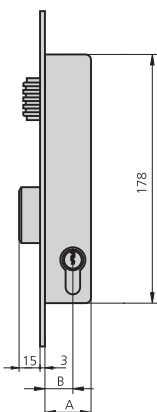

- Rodillo vaivén regulable y palanca
- Cilindro 5990/2525

1984V20/6	20	33	13,25	Al	CN	1	20
1984V25/6	25	38	13,25	Al	CN	1	20
1984V30/6	30	43	13,25	Al	CN	1	20

**Opciones de cerradero**

- CE1984/6

**PALANCA DESLIZANTE ENTRE EJES 85 CILINDRO EUROPERFIL LEVA LARGA**

**SERIE 1995**

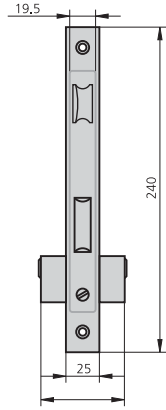

**CARACTERÍSTICAS**

- Frente hierro niquelado ó acero inoxidable
- Caja bicromatada
- Palanca deslizante
- Picaporte reversible
- Cuadradillo de 8 mm
- Cilindro europerfil
- 2 escudos de nylon ref. ES1984
- Tornillo de fijación de cilindro

**ACCESORIOS OPCIONALES**

- Cerraderos según cerradura (ver abajo)
- Amplia gama de cilindros (ver página 122 -142)

DESCRIPCIÓN	REF.	MEDIDAS		LEVA	ACABADOS		UDS	
		B	A		FRENTE	CILINDRO		

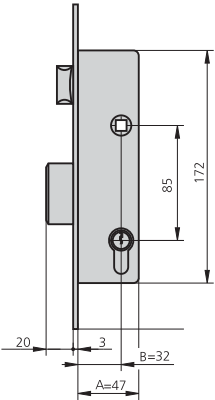

- Picaporte y palanca
- Cilindro 5982/2525

1995/32/0	32	47	15	HN	CN	1	20
1995/32/5	32	47	15	HN	CL	1	20
1995/32/6	32	47	15	Al	CN	1	20

- Opciones de cerradero**
- CE1984/0 o CE1984/6

- Opciones cerraderos eléctricos**
- CELC45/6A o CELC45/6AD

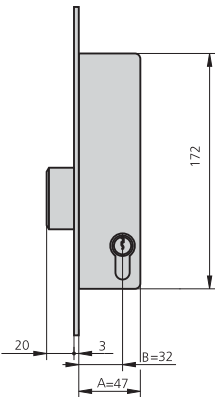

- Sólo palanca
- Cilindro 5982/2525/4

1995A32/6	32	47	15	Al	CN	1	20
-----------	----	----	----	----	----	---	----

- Opciones de cerradero**
- CE2994S/6

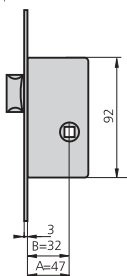

- Sólo picaporte
- Sin cilindro

1995R32/0	32	47		HN		1	30
-----------	----	----	--	----	--	---	----

DESCRIPCIÓN	REF.	MEDIDAS		LEVA	ACABADOS		UDS	
		B	A		FRENTE	CILINDRO		

- Sólo picaporte
- Cilindro 5982T40/4

1995T32/6    32    47    15    Al    CN    1    20

**Opciones cerraderos eléctricos**

- CELC45T/6A o CELC45T/6AD

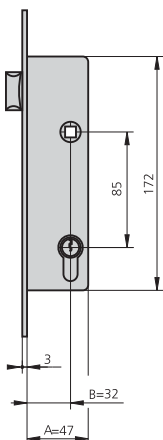

- Rodillo vaivén regulable y palanca
- Cilindro 5982/2525/4

1995V32/6    32    47    15    Al    CN    1    20

**Opciones de cerradero**

- CE1984/6

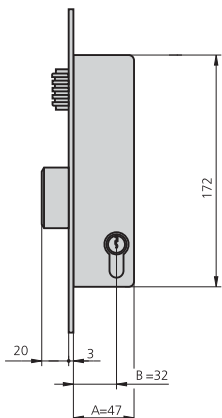

CARPINTERÍA METÁLICA

**PALANCA GANCHO ENTRE EJES 85 CILINDRO EUROPERFIL**

**SERIE 190**

**CARACTERÍSTICAS**

- Frente de 24 mm
- Picaporte reversible
- Caja bicromatada de 15 mm
- Cuadradillo de 8 mm
- Cilindro europerfil
- 2 escudos de nylon ref. ES1984
- Tornillo de fijación de cilindro

**ACCESORIOS OPCIONALES**

- Gama completa de cilindros (ver páginas 122 - 142)

DESCRIPCIÓN	REF.	MEDIDAS		LEVA	ACABADOS		UDS	
		B	A		FRENTE	CILINDRO		

- Picaporte y palanca
- Cilindro 5990/2525

**Opciones de cerradero**

- CE190/0 o CE190/6

**Opciones cerraderos eléctricos**

- CELC45/6A o CELC45/6AD

190/23/0	20	33	13,25	HN	CN	1	20
190/23/5	20	33	13,25	HN	CL	1	20
190/23/6	20	33	13,25	AI	CN	1	20
190/28/0	25	38	13,25	HN	CN	1	20
190/28/5	25	38	13,25	HN	CL	1	20
190/28/6	25	38	13,25	AI	CN	1	20
190/33/0	30	43	13,25	HN	CN	1	20
190/33/5	30	43	13,25	HN	CL	1	20
190/33/6	30	43	13,25	AI	CN	1	20

- Solo palanca
- Cilindro 5990/2525

**Opciones de cerradero**

- CE190/0 o CE190/6

190A23/0	20	33	13,25	HN	CN	1	20
190A23/5	20	33	13,25	HN	CL	1	20
190A23/6	20	33	13,25	AI	CN	1	20
190A28/0	25	38	13,25	HN	CN	1	20
190A28/5	25	38	13,25	HN	CL	1	20
190A28/6	25	38	13,25	AI	CN	1	20
190A33/0	30	43	13,25	HN	CN	1	20
190A33/5	30	43	13,25	HN	CL	1	20
190A33/6	30	43	13,25	AI	CN	1	20

- 58 -

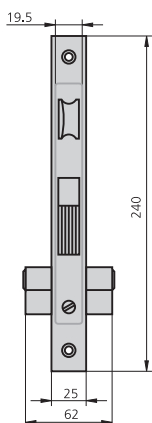
**CARACTERÍSTICAS**

- Frente hierro niquelado o acero inoxidable
- Caja bicromatada
- Palanca basculante de gancho
- Picaporte reversible
- Cuadradillo de 8 mm
- Cilindro europerfil
- 2 escudos de nylon ref. ES1984
- Tornillo de fijación de cilindro

**ACCESORIOS OPCIONALES**

- Gama completa de cilindros (ver páginas 122 - 142)

DESCRIPCIÓN	REF.	MEDIDAS		LEVA	ACABADOS		UDS	
		B	A		FRENTE	CILINDRO		
<ul style="list-style-type: none"> <li>• Picaporte y palanca</li> <li>• Cilindro 5990/2525 o 5982/2525</li> <li>• Cerradero CE1990/0</li> </ul> <b>Opciones cerraderos eléctricos</b> <ul style="list-style-type: none"> <li>• CELC45/6A o CELC45/6AD</li> </ul>	1990/20/0	20	33	13,25	HN	CN	1	20
	1990/20/5	20	33	13,25	HN	CL	1	20
	1990/20/6	20	33	13,25	AI	CN	1	20
	1990/25/0	25	38	13,25	HN	CN	1	20
	1990/25/5	25	38	13,25	HN	CL	1	20
	1990/25/6	25	38	13,25	AI	CN	1	20
	1990/32/0	32	47	15	HN	CN	1	20
	1990/32/5	32	47	15	HN	CL	1	20
	1990/32/6	32	47	15	AI	CN	1	20
	<ul style="list-style-type: none"> <li>• Sólo palanca</li> <li>• Cilindro 5990/2525 o 5982/2525</li> <li>• Cerradero CE1990/0</li> </ul>	1990A20/0	20	33	13,25	HN	CN	1
1990A20/5		20	33	13,25	HN	CL	1	20
1990A20/6		20	33	13,25	AI	CN	1	20
1990A25/0		25	38	13,25	HN	CN	1	20
1990A25/5		25	38	13,25	HN	CL	1	20
1990A25/6		25	38	13,25	AI	CN	1	20
1990A32/0		32	47	15	HN	CN	1	20
1990A32/5		32	47	15	HN	CL	1	20
1990A32/6		32	47	15	AI	CN	1	20
<ul style="list-style-type: none"> <li>• Rodillo vaivén regulable y palanca</li> <li>• Cilindro 5990/2525 o 5982/2525</li> <li>• Cerradero CE1990/0</li> </ul>		1990V20/0	20	33	13,25	HN	CN	1
	1990V20/5	20	33	13,25	HN	CL	1	20
	1990V20/6	20	33	13,25	AI	CN	1	20
	1990V25/0	25	38	13,25	HN	CN	1	20
	1990V25/5	25	38	13,25	HN	CL	1	20
	1990V25/6	25	38	13,25	AI	CN	1	20
	1990V32/0	32	47	15	HN	CN	1	20
	1990V32/5	32	47	15	HN	CL	1	20
	1990V32/6	32	47	15	AI	CN	1	20



**PALANCA GANCHO ENTRE EJES 85 CILINDRO EUROPERFIL**

**SERIE 1994**

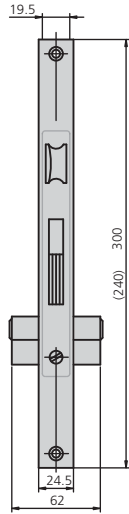

**CARACTERÍSTICAS**

- Frente de acero inoxidable
- Caja bicromatada
- Palanca basculante de gancho
- Picaporte reversible
- Cuadradillo de 8 mm
- Cilindro europerfil
- Tornillo de fijación de cilindro
- Cerradero según cerradura

**ACCESORIOS OPCIONALES**

- Gama completa de cilindros (ver páginas 122 - 142)

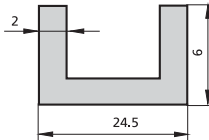

**FRETE U**



**FRETE LISO**

DESCRIPCIÓN	REF.	MEDIDAS		LEVA	ACABADOS		UDS	
		B	A		FRENTE	CILINDRO		

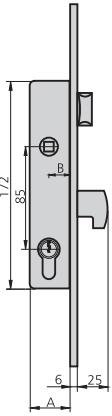

**FRETE U**

- Picaporte y palanca
  - Cilindro 5982/2525/4
  - Cerradero CE1994/6
- Opciones cerraderos eléctricos**
- CELC45/6A o CELC45/6AD

1994/25/6	18	33	15	Al	CN	1	10
1994/30/6	23	38	15	Al	CN	1	10
1994/35/6	28	43	15	Al	CN	1	10

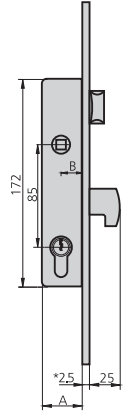

**FRETE LISO**

- Picaporte y palanca
  - Cilindro 5982/2525/4
  - Cilindro CE1994/6
- Opciones cerraderos eléctricos**
- CELC45/6A o CELC45/6AD

1994/25/6L	22	37	15	Al	CN	1	20
1994/30/6L	27	42	15	Al	CN	1	20
1994/35/6L	32	47	15	Al	CN	1	20

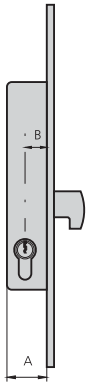
DESCRIPCIÓN	REF.	MEDIDAS		LEVA	ACABADOS		UDS	
		B	A		FRENTE	CILINDRO		
 <ul style="list-style-type: none"> <li>• Sólo palanca</li> <li>• Cilindro 5982/2525/4</li> <li>• Cerradero CE1994/6</li> </ul>	1994A25/6	18	33	15	Al	CN	1	10
	1994A30/6	23	38	15	Al	CN	1	10
	1994A35/6	28	43	15	Al	CN	1	10
<ul style="list-style-type: none"> <li>• Sólo palanca</li> <li>• Cilindro 5982/2525/4</li> <li>• Cerradero CE1994/6</li> </ul>	1994A25/6L	22	37	15	Al	CN	1	20
	1994A30/6L	27	42	15	Al	CN	1	20
	1994A35/6L	32	47	15	Al	CN	1	20

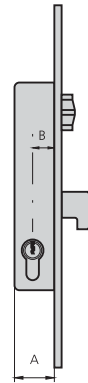
 <ul style="list-style-type: none"> <li>• Rodillo vaivén regulable y palanca</li> <li>• Cilindro 5982/2525/4</li> <li>• Cerradero CE1994/6</li> </ul>	1994V25/6	18	33	15	Al	CN	1	10
	1994V30/6	23	38	15	Al	CN	1	10
	1994V35/6	28	43	15	Al	CN	1	10
<ul style="list-style-type: none"> <li>• Rodillo vaivén regulable y palanca</li> <li>• Cilindro 5982/2525/4</li> <li>• Cerradero CE1994/6</li> </ul>	1994V25/6L	22	37	15	Al	CN	1	20
	1994V30/6L	27	42	15	Al	CN	1	20
	1994V35/6L	32	47	15	Al	CN	1	20

**MULTIPUNTO PALANCA GANCHO ENTRE EJES 85**

**SERIE 2994**

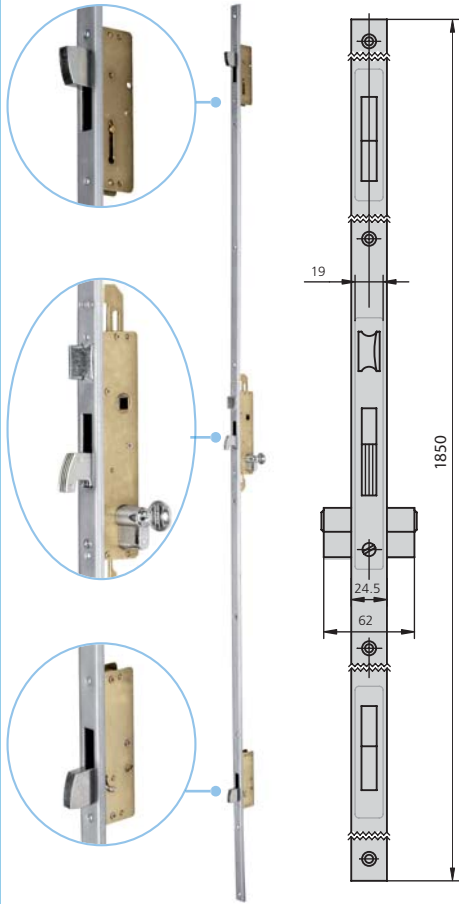

**CARACTERÍSTICAS**

- Frente de acero inoxidable
- Caja bicromatada
- Palanca basculante de gancho
- Picaporte reversible
- Cuadradillo de 8 mm
- Cilindro euoperfil de seguridad
- Tornillo de fijación de cilindro
- Cerradero según cerradura
- Escudo de seguridad BT194/1N

**ACCESORIOS OPCIONALES**

- Gama completa de cilindros (ver páginas 122 - 142)

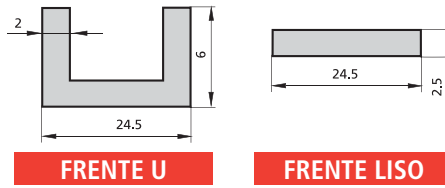

**DESCRIPCIÓN**

**REF.**

**MEDIDAS**

**LEVA**

**ACABADOS**

**UDS**

**B A**

**FRENTE CILINDRO**

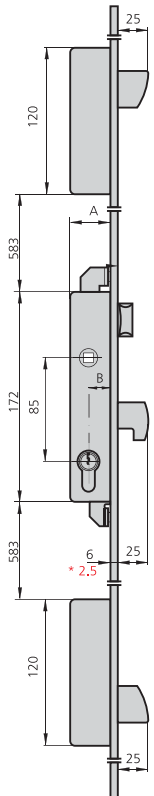
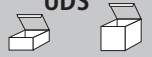

**FRENTE U**

- Picaporte y palanca
- Cilindro 6982/2525/4
- Cerradero CE1994/6
- Cerradero alto/bajo CE2994S/6
- Escudo de seguridad BT194/1N

2994/25/6	18	33	15	Al	CN	1
2994/30/6	23	38	15	Al	CN	1
2994/35/6	28	43	15	Al	CN	1

**FRENTE LISO**

- Picaporte y palanca
- Cilindro 6982/2525/4
- Cerradero CE1994/6
- Cerradero alto/bajo CE2994S/6
- Escudo de seguridad BT194/1N

2994/25/6L	22	37	15	Al	CN	1
2994/30/6L	27	42	15	Al	CN	1
2994/35/6L	32	47	15	Al	CN	1

\* Medidas en frente liso

DESCRIPCIÓN	REF.	MEDIDAS		LEVA	ACABADOS		UDS	
		B	A		FRENTE	CILINDRO		
<ul style="list-style-type: none"> <li>• Sólo palanca</li> <li>• Cilindro 6982/2525/4</li> <li>• Cerradero CE1994/6</li> <li>• Cerradero alto/bajo CE2994S/6</li> <li>• Escudo de seguridad BT194/1N</li> </ul>	2994A25/6	18	33	15	Al	CN	1	
	2994A30/6	23	38	15	Al	CN	1	
	2994A35/6	28	43	15	Al	CN	1	
<ul style="list-style-type: none"> <li>• Sólo palanca</li> <li>• Cilindro 6982/2525/4</li> <li>• Cerraderos CE1994/6</li> <li>• Cerradero alto/bajo CE2994S/6</li> <li>• Escudo de seguridad BT194/1N</li> </ul>	2994A25/6L	22	37	15	Al	CN	1	
	2994A30/6L	27	42	15	Al	CN	1	
	2994A35/6L	32	47	15	Al	CN	1	

<ul style="list-style-type: none"> <li>• Rodillo vaivén regulable y palanca</li> <li>• Cilindro 6982/2525/4</li> <li>• Cerraderos CE1994/6</li> <li>• Cerraderos alto/bajo CE2994S/6</li> <li>• Escudo de seguridad BT194/1N</li> </ul>	2994V25/6	18	33	15	Al	CN	1	
	2994V30/6	23	38	15	Al	CN	1	
	2994V35/6	28	43	15	Al	CN	1	
<ul style="list-style-type: none"> <li>• Rodillo vaivén regulable y palanca</li> <li>• Cilindro 6982/2525/4</li> <li>• Cerraderos CE1994/6</li> <li>• Cerraderos alto/bajo CE2994S/6</li> <li>• Escudo de seguridad BT194/1N</li> </ul>	2994V25/6L	22	37	15	Al	CN	1	
	2994V30/6L	27	42	15	Al	CN	1	
	2994V35/6L	32	47	15	Al	CN	1	

## MULTIPUNTO PALANCA GANCHO ENTRE EJES 85

## SERIE 3994

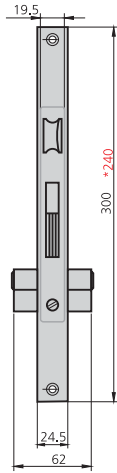

### CARACTERÍSTICAS

- Cerradura de 3 puntos mediante barra roscada de M8
- Frente de acero inoxidable
- Caja bicromatada
- Palanca basculante de gancho
- Picaporte reversible
- Cuadradillo de 8 mm
- Cilindro de seguridad
- Tornillo de fijación de cilindro
- Cerradero según cerradura
- Escudo de seguridad ref. BT194/1N

### ACCESORIOS OPCIONALES

- Gama completa de cilindros (ver páginas 122 - 142)

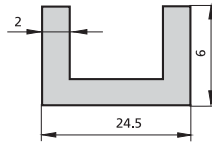

**FRENTE U**

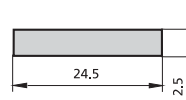

**FRENTE LISO**

\* Medidas en frente liso

DESCRIPCIÓN	REF.	MEDIDAS		LEVA	ACABADOS		UDS	
		B	A		FRENTE	CILINDRO		

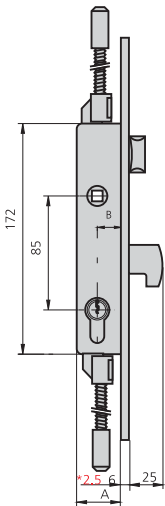

**FRENTE U**

- Picaporte y palanca
- Cilindro 6982/2525/4
- Cerradero CE1994/6
- Escudo de seguridad BT194/1N

3994/25/6	18	33	15	Al	CN	1	10
3994/30/6	23	38	15	Al	CN	1	10
3994/35/6	28	43	15	Al	CN	1	10

**FRENTE LISO**

- Picaporte y palanca
- Cilindro 6982/2525/4
- Cerradero CE1994/6
- Escudo de seguridad BT194/1N

3994/25/6L	22	37	15	Al	CN	1	10
3994/30/6L	27	42	15	Al	CN	1	10
3994/35/6L	32	47	15	Al	CN	1	10

\* Medidas en frente liso

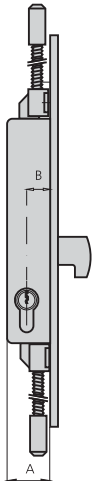

**FRENTE U**

- Sólo palanca
- Cilindro 6982/2525/4
- Cerradero CE1994/6
- Escudo de seguridad BT194/1N

3994A25/6	18	33	15	Al	CN	1	10
3994A30/6	23	38	15	Al	CN	1	10
3994A35/6	28	43	15	Al	CN	1	10

**FRENTE LISO**

- Sólo palanca
- Cilindro 6982/2525/4
- Cerradero CE1994/6
- Escudo de seguridad BT194/1N

3994A25/6L	22	37	15	Al	CN	1	10
3994A30/6L	27	42	15	Al	CN	1	10
3994A35/6L	32	47	15	Al	CN	1	10

DESCRIPCIÓN	REF.	MEDIDAS		LEVA	ACABADOS		UDS	
		B	A		FRENTE	CILINDRO		

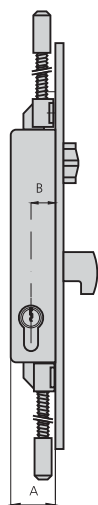
**FRENTE U**

- Rodillo vaivén regulable y palanca
- Cilindro 6982/2525/4
- Cerradero CE1994/6
- Escudo de seguridad BTI94/1N

3994V25/6	18	33	15	Al	CN	1	10
3994V30/6	23	38	15	Al	CN	1	10
3994V35/6	28	43	15	Al	CN	1	10

**FRENTE LISO**

- Rodillo vaivén regulable y palanca
- Cilindro 6982/2525/4
- Cerradero CE1994/6
- Escudo de seguridad BTI94/1N

3994V25/6L	22	37	15	Al	CN	1	10
3994V30/6L	27	42	15	Al	CN	1	10
3994V35/6L	32	47	15	Al	CN	1	10

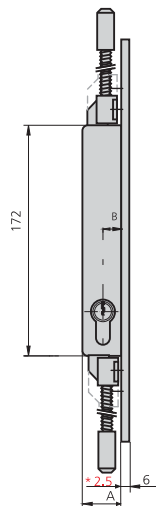
**FRENTE U**

- Sin palanca y sin picaporte
- Cilindro 6982/2525/4
- Escudo de seguridad BTI94/1N

3994F25/6	18	33	15	Al	CN	1	10
3994F30/6	23	38	15	Al	CN	1	10
3994F35/6	28	43	15	Al	CN	1	10

**FRENTE LISO**

- Sin palanca y sin picaporte
- Cilindro 6982/2525/4
- Escudo de seguridad BTI94/1N

3994F25/6L	22	37	15	Al	CN	1	10
3994F30/6L	27	42	15	Al	CN	1	10
3994F35/6L	32	47	15	Al	CN	1	10

**PALANCA DESLIZANTE ENTRE EJES 92 CILINDRO EUROPERFIL**

**SERIE 1992**

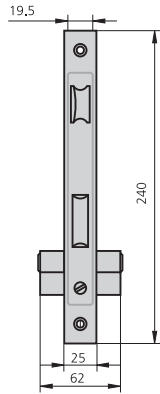

**CARACTERÍSTICAS**

- Frente de acero inoxidable
- Caja bicromatada
- Palanca deslizante
- Picaporte reversible
- Cuadradillo de 8 mm
- Cilindro europerfil
- 2 escudos de nylon ref. ES1984
- Tornillo de fijación de cilindro

**ACCESORIOS OPCIONALES**

- Cerraderos según cerradura (ver abajo)
- Gama completa de cilindros (ver páginas 122 - 142)

DESCRIPCIÓN	REF.	MEDIDAS		LEVA	ACABADOS		UDS	
		B	A		FRENTE	CILINDRO		

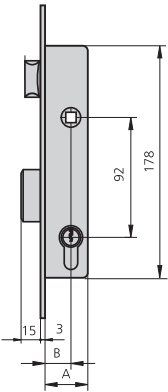

- Picaporte y palanca
- Cilindro 5990/2525

1992/20/6	20	33	13,25	Al	CN	1	20
1992/25/6	25	38	13,25	Al	CN	1	20
1992/30/6	30	43	13,25	Al	CN	1	20

- Opciones de cerradero**
- CE1984/6

**Opciones cerraderos eléctricos**

- CELC45/6A o CELC45 /6AD

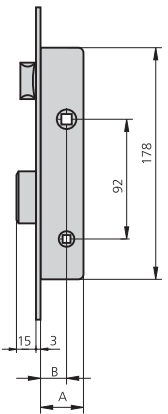

- Cerradura de condena
- Sin cilindro

1992C20/6	20	33		Al		2	40
1992C25/6	25	38		Al		2	40
1992C30/6	30	43		Al		2	40

- Opciones de cerradero**
- CE1984/6

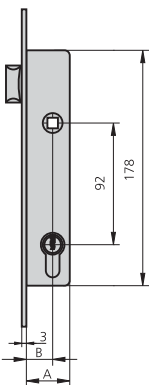

- Sólo picaporte
- Cilindro 55982T40/4

1992T20/6	20	33	15	Al	CN	1	20
1992T25/6	25	38	15	Al	CN	1	20
1992T30/6	30	43	15	Al	CN	1	20

**Opciones cerraderos eléctricos**

- CELC45T/6A o CELC45T/6AD

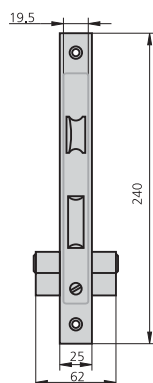

**CARACTERÍSTICAS**

- Frente hierro niquelado o acero inoxidable
- Caja bicromatada
- Palanca deslizante
- Picaporte reversible
- Cuadradillo de 8 mm
- Cilindro europerfil
- 2 escudos de nylon ref. ES1984
- Tornillo de fijación de cilindro

**ACCESORIOS OPCIONALES**

- Cerraderos según cerradura (ver abajo)
- Gama completa de cilindros (ver páginas 122 - 142)

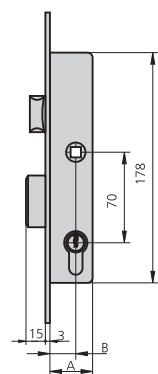
DESCRIPCIÓN	REF.	MEDIDAS		LEVA	ACABADOS		UDS	
		B	A		FRENTE	CILINDRO		



- Picaporte y palanca
- Cilindro 5990/2525

**Opciones de cerradero**

- CE1983/0 o CE1983/6

**Opciones cerraderos eléctricos**

- CELC45/6A o CELC45 /6AD

1983/20/0	20	33	13,25	HN	CN	1	20
1983/20/5	20	33	13,25	HN	CL	1	20
1983/20/6	20	33	13,25	Al	CN	1	20
1983/25/0	25	38	13,25	HN	CN	1	20
1983/25/5	25	38	13,25	HN	CL	1	20
1983/25/6	25	38	13,25	Al	CN	1	20
1983/30/0	30	43	13,25	HN	CN	1	20
1983/30/5	30	43	13,25	HN	CL	1	20
1983/30/6	30	43	13,25	Al	CN	1	20

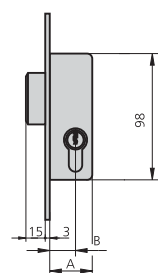

- Sólo palanca
- Cilindro 5990/2525

**Opciones de cerradero**

- CE2994S/6

1983A20/0	20	33	13,25	HN	CN	1	30
1983A20/5	20	33	13,25	HN	CL	1	30
1983A25/0	25	38	13,25	HN	CN	1	30
1983A25/5	25	38	13,25	HN	CL	1	30
1983A30/0	30	43	13,25	HN	CN	1	30
1983A30/5	30	43	13,25	HN	CL	1	30

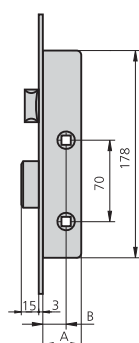

- Cerradura de condensa
- Sin cilindro

**Opciones de cerradero**

- CE1983/6

1983C20/6	20	33		Al		2	40
1983C25/6	25	38		Al		2	40
1983C30/6	30	43		Al		2	40



**PALANCA DESLIZANTE ENTRE EJES 70 CILINDRO EUROPERFIL**

**SERIE 1983**

DESCRIPCIÓN	REF.	MEDIDAS		LEVA	ACABADOS		UDS	
		B	A		FRENTE	CILINDRO		
 <ul style="list-style-type: none"> <li>• Cerradura de sólo picaporte</li> <li>• Sin cilindro</li> </ul>	1983R20/0	20	33		HN		2	60
	1983R25/0	25	38		HN		2	60
	1983R30/0	30	43		HN		2	60
 <ul style="list-style-type: none"> <li>• Cerradura de sólo vaivén</li> <li>• Sin cilindro</li> </ul>	1983RV/0		33		HN		2	60
 <ul style="list-style-type: none"> <li>• Sólo picaporte</li> <li>• Cilindro 5982T40/4</li> </ul> <p><b>Opciones de cerraderos eléctricos</b></p> <ul style="list-style-type: none"> <li>• CELC45T/6A o CELC45T/6AD</li> </ul>	1983T20/6	20	33	15	Al	CN	1	20
	1983T25/6	25	38	15	Al	CN	1	20
	1983T30/6	30	43	15	Al	CN	1	20

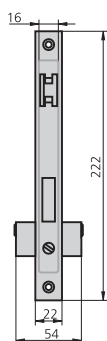
**CARACTERÍSTICAS**

- Frente de hierro niquelado o acero inoxidable
- Caja bicromatada
- Palanca deslizante
- Picaporte reversible
- Cuadradillo de 8 mm
- Cilindro ovalado monoblock (5963)
- 2 escudos de nylon ref. ES1963
- Tornillo de fijación de cilindro

**ACCESORIOS OPCIONALES**

- Cerraderos según cerradura (ver abajo)
- Cilindros (ver página 136)

DESCRIPCIÓN	REF.	MEDIDAS		LEVA	ACABADOS		UDS	
		B	A		FRENTE	CILINDRO		

- Picaporte y palanca
- Cilindro 5963/2222

1963/0	12	22	HN	CN	1	20
1963/5	12	22	HN	CL	1	20
1963/6	12	22	Al	CN	1	20

- Opciones de cerradero**
- CE1984/0 o CE1984/6

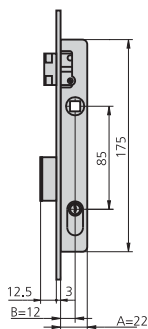

- Cerradura de sólo palanca
- Cilindro 5963/2222

1963A/0	12	22	HN	CN	1	30
1963A/5	12	22	HN	CL	1	30
1963A/6	12	22	Al	CN	1	30

- Opciones de cerradero**
- CE2994S/6

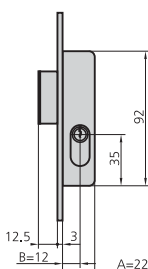

- Cerradura de condena
- Sin cilindro

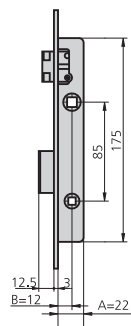

1963C/6	12	22	Al		2	40
---------	----	----	----	--	---	----

- Opciones de cerradero**
- CE1984/6



**PALANCA DESLIZANTE ENTRE EJES 85 CILINDRO OVALADO MONOBLOCK**

**SERIE 1963**

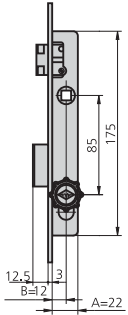
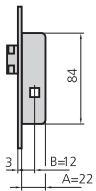
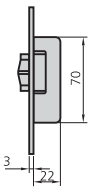
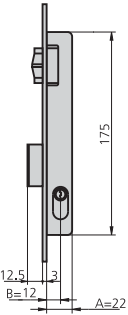
DESCRIPCIÓN	REF.	MEDIDAS		LEVA	ACABADOS		UDS	
		B	A		FRENTE	CILINDRO		
 <ul style="list-style-type: none"> <li>• Cerradura de pomo condensa</li> <li>• Sin cilindro</li> </ul> <p><b>Opciones de cerradero</b></p> <ul style="list-style-type: none"> <li>• CE1984/6</li> </ul>	1963CP16/6	12	22		Al		1	20
 <ul style="list-style-type: none"> <li>• Cerradura de sólo picaporte</li> <li>• Sin cilindro</li> </ul> <p><b>Opciones de cerradero</b></p> <ul style="list-style-type: none"> <li>• CE196R/6L</li> </ul>	1963R/0	12	22		HN		2	60
 <ul style="list-style-type: none"> <li>• Cerradura de sólo vaivén</li> <li>• Sin cilindro</li> </ul> <p><b>Opciones de cerradero</b></p> <ul style="list-style-type: none"> <li>• CE196R/6L</li> </ul>	1963RV/0		22		HN		2	60
 <ul style="list-style-type: none"> <li>• Rodillo vaivén regulable y palanca</li> <li>• Cilindro 5963/2222</li> </ul> <p><b>Opciones de cerradero</b></p> <ul style="list-style-type: none"> <li>• CE1984/0 o CE1984/6</li> </ul>	1963V/0	12	22		HN	CN	1	20
	1963V/5	12	22		HN	CL	1	20
	1963V/6	12	22		Al	CN	1	20

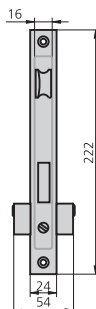

**CARACTERÍSTICAS**

- Frente de hierro niquelado
- Caja bicromatada
- Palanca deslizante
- Picaporte reversible
- Cuadradillo de 8 mm
- Cilindro ovalado monoblock (5963)
- 2 escudos de nylon ref. ES1963
- Tornillo de fijación de cilindro

**ACCESORIOS OPCIONALES**

- Cerraderos según cerradura (ver abajo)
- Cilindros (ver página 136)

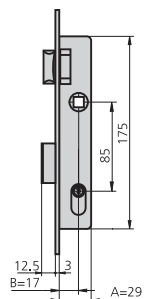
DESCRIPCIÓN	REF.	MEDIDAS		LEVA	ACABADOS		UDS	
		B	A		FRENTE	CILINDRO		



- Picaporte y palanca
- Cilindro 5963/2222

1975/0	17	29	HN	CN	1	20
1975/5	17	29	HN	CL	1	20

**Opciones de cerradero**

- CE1984/0

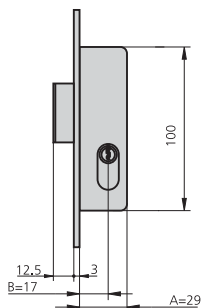

- Sólo palanca
- Cilindro 5963/2222

1975A/0	17	29	HN	CN	1	30
1975A/5	17	29	HN	CL	1	30

**Opciones de cerradero**

- CE2994S/6

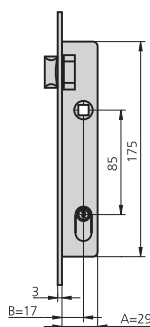

- Sólo picaporte
- Cilindro 5963T36

1975T/0	17	29	HN	CN	1	20
1975T/5	17	29	HN	CL	1	20

**Opciones de cerradero**

- CEC41T/6A o CEC41T/6AD

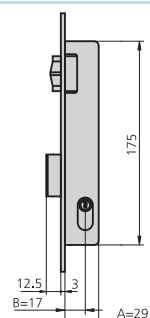

- Rodillo vaivén regulable y palanca
- Cilindro 5963/2222

1975V/0	17	29	HN	CN	1	20
1975V/5	17	29	HN	CL	1	20

**Opciones de cerradero**

- CE1984/0

**PALANCA DESLIZANTE ENTRE EJES 74 CILINDRO OVALADO DE VÁSTAGOS**

**SERIES 1964**

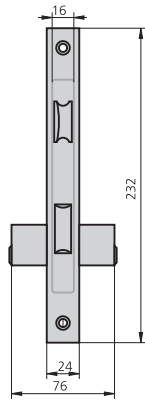

**CARACTERÍSTICAS**

- Frente de hierro niquelado o acero inoxidable
- Caja bicromatada
- Palanca deslizante
- Picaporte reversible
- Cuadradillo de 8 mm
- Cilindro ovalado monoblock (5964)
- 2 escudos de nylon ref. ES1964
- Tornillo de fijación de cilindro

**ACCESORIOS OPCIONALES**

- Cerraderos según cerradura (ver abajo)
- Cilindros (ver página 140)

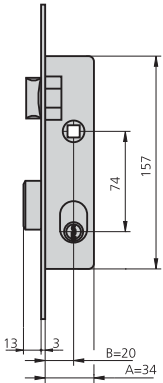
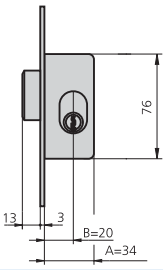
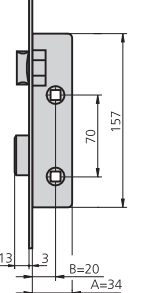
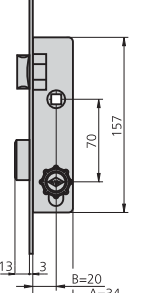
DESCRIPCIÓN	REF.	MEDIDAS		LEVA	ACABADOS		UDS	
		B	A		FRENTE	CILINDRO		
 <ul style="list-style-type: none"> <li>• Picaporte y palanca</li> <li>• Cilindro ovalado 5964/2525</li> </ul> <p><b>Opciones de cerradero</b></p> <ul style="list-style-type: none"> <li>• CE1984/0 o CE1984/6</li> </ul>	1964/0	20	34	HN	CN	1	20	
	1964/5	20	34	HN	CL	1	20	
	1964/6	20	34	AI	CN	1	20	
 <ul style="list-style-type: none"> <li>• Cerradura de sólo palanca</li> <li>• Cilindro ovalado 5964/2525</li> </ul> <p><b>Opciones de cerradero</b></p> <ul style="list-style-type: none"> <li>• CE2994S/6</li> </ul>	1964A/0	20	34	HN	CN	1	30	
	1964A/5	20	34	HN	CL	1	30	
 <ul style="list-style-type: none"> <li>• Cerradura de condena</li> <li>• Sin cilindro</li> </ul> <p><b>Opciones de cerradero</b></p> <ul style="list-style-type: none"> <li>• CE1984/0 o CE1984/6</li> </ul>	1964C/0	20	34	HN		2	40	
	1964C/6	20	34	AI		2	40	
 <ul style="list-style-type: none"> <li>• Cerradura de pomo condena</li> <li>• Sin cilindro</li> </ul> <p><b>Opciones de cerradero</b></p> <ul style="list-style-type: none"> <li>• CE1984/6</li> </ul>	1964CP/6	20	34	AI		1	20	

DESCRIPCIÓN	REF.	MEDIDAS		LEVA	ACABADOS		UDS	
		B	A		FRENTE	CILINDRO		
<ul style="list-style-type: none"> <li>Cerradura de sólo picaporte</li> <li>Sin cilindro</li> </ul> <p><b>Opciones de cerradero</b></p> <ul style="list-style-type: none"> <li>CE196R/6L</li> </ul>	1964R/0	20	34		HN		2	60
	<ul style="list-style-type: none"> <li>Cerradura de sólo vaivén</li> <li>Sin cilindro</li> </ul> <p><b>Opciones de cerradero</b></p> <ul style="list-style-type: none"> <li>CE196R/6L</li> </ul>	1964RV/0		34		HN		2
<ul style="list-style-type: none"> <li>Cerradura de sólo picaporte</li> <li>Cilindro 5964T25</li> </ul> <p><b>Opciones de cerraderos eléctricos</b></p> <ul style="list-style-type: none"> <li>CEC41T/6A o CEC41T/6AD</li> </ul>		1964T/0	20	34		HN	CN	1
	1964T/5	20	34		HN	CL	1	20
	1964T/6	20	34		AI	CN	1	20
	<ul style="list-style-type: none"> <li>Rodillo vaivén regulable y palanca</li> <li>Cilindro 5964/2525</li> </ul> <p><b>Opciones de cerradero</b></p> <ul style="list-style-type: none"> <li>CE1984/0 o CE1984/6</li> </ul>	1964V/0	20	34		HN	CN	1
1964V/5		20	34		HN	CL	1	20
1964V/6		20	34		AI	CN	1	20

**CERRADURA PARA PUERTAS DE ZÓCALO CON CILINDRO OVALADO DE VÁSTAGOS**

**SERIE 1981**

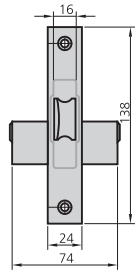

**CARACTERÍSTICAS**

- Frente de hierro niquelado
- Caja bicromatada
- Picaporte extensible y reversible
- Accionamiento extensible con llave
- Accionamiento del picaporte con llave y manilla
- Cuadradillo de 8 mm
- Cilindro ovalado monoblock (5081) o cilindro redondo monoblock (5181)
- 2 escudos de nylon ref. ES1964 ó ES1962/4
- Tornillo de fijación de cilindro
- Cerradero CE1991/0

**ACCESORIOS OPCIONALES**

- Cilindro (ver página 137)

DESCRIPCIÓN	REF.	MEDIDAS		LEVA	ACABADOS		UDS	
		B	A		FRENTE	CILINDRO		

**CILINDRO OVALADO**

- Cilindro ovalado 5081/3030
- Cerradero CE1991/0
- Escudo de nylon ES1964

1981/60/0	57	152	HN	CN	1	20
1981/60/5	57	152	HN	CL	1	20

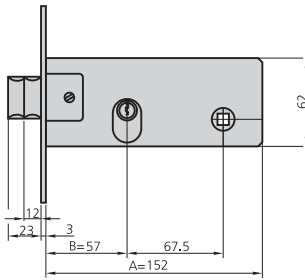

**CILINDRO REDONDO**

- Cilindro redondo 5181/3030
- Cerradero CE1991/0
- Escudo ES1962/4

11981/60/0	57	152	HN	CN	1	20
11981/60/5	57	152	HN	CL	1	20

**CILINDRO OVALADO**

- Vaivén extensible
- Cilindro ovalado 5081/3030
- Cerradero CE1991/0
- Escudo de nylon ES1964

1981V60/0	57	152	HN	CN	1	20
1981V60/5	57	152	HN	CL	1	20

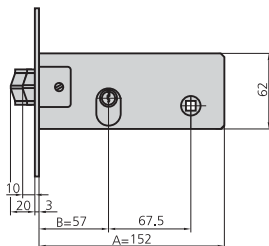

**CILINDRO REDONDO**

- Vaivén extensible
- Cilindro redondo 5181/3030
- Cerradero CE1991/0
- Escudo ES1962/4

11981V60/0	57	152	HN	CN	1	20
11981V60/5	57	152	HN	CL	1	20

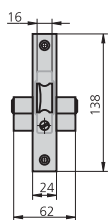

**CARACTERÍSTICAS**

- Frente de hierro niquelado
- Caja bicromatada
- Picaporte extensible y reversible
- Accionamiento extensible con llave
- Accionamiento del picaporte con llave y manilla
- Cuadradillo de 8 mm
- Cilindro europerfil
- 2 escudos de nylon ref. ES1984
- Tornillo de fijación de cilindro
- Cerradero CE1991/0

**ACCESORIOS OPCIONALES**

- Gama completa de cilindros (ver páginas 122 - 142)

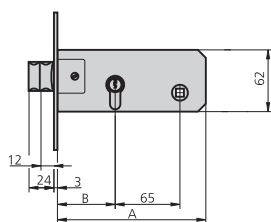
DESCRIPCIÓN	REF.	MEDIDAS		LEVA	ACABADOS		UDS	
		B	A		FRENTE	CILINDRO		
• Picaporte extensible y reversible	1991/60/0	58	149	15	HN	CN	1	20
• Cilindro europerfil 5982/2525	1991/60/5	58	149	15	HN	CL	1	20
• Cerradero CE1991/0	1991/70/0	68	159	15	HN	CN	1	20
	1991/70/5	68	159	15	HN	CL	1	20





**CERRADURA DE SÓLO GANCHO CON CILINDRO OVALADO DE VÁSTAGOS**

**SERIE 1968**

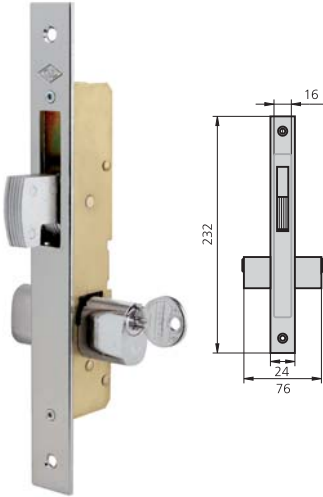

**CARACTERÍSTICAS**

- Frente de hierro niquelado
- Caja bicromatada
- Palanca de gancho
- Cilindro ovalado monoblock de vástagos
- 2 escudos de nylon ref. ES1964
- Tornillo de fijación de cilindro

**ACCESORIOS OPCIONALES**

DESCRIPCIÓN	REF.	MEDIDAS		LEVA	ACABADOS		UDS	
		B	A		FRENTE	CILINDRO		
<ul style="list-style-type: none"> <li>• Cerradura con palanca basculante de gancho</li> <li>• Cilindro 5968/2525</li> </ul>	1968/0	17	34		HN	CN	1	20
	1968/5	17	34		HN	CL	1	20

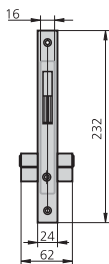

**CARACTERÍSTICAS**

- Frente de hierro niquelado
- Caja bicromatada
- Palanca de gancho
- Cilindro europerfil
- 2 escudos de nylon ref. E51984
- Tornillo de fijación de cilindro

**ACCESORIOS OPCIONALES**

- Gama completa de cilindros (ver páginas 122 - 142)

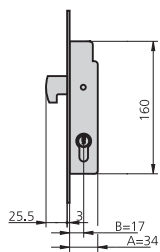
DESCRIPCIÓN	REF.	MEDIDAS		LEVA	ACABADOS		UDS	
		B	A		FRENTE	CILINDRO		
<ul style="list-style-type: none"> <li>• Cerradura con palanca basculante de gancho</li> <li>• Cilindro 5982/2525</li> </ul>	1982/0	17	34		HN	CN	1	20
	1982/5	17	34		HN	CL	1	20



**CERRADURA DE SÓLO PICAPORTE PARA PUERTAS METÁLICAS**

**SERIE 1979**

**CARACTERÍSTICAS**

- Frente de hierro niquelado
- Caja bicromatada
- Picaporte reversible accionado con llave por el exterior y con pomo por el interior o accionamiento con llave por ambos lados
- Cilindro ovalado monoblock de vástagos
- 2 escudos de nylon ref. ES1964
- Tornillo de fijación de cilindro

**ACCESORIOS OPCIONALES**

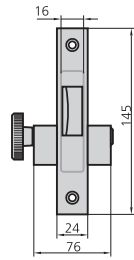

**DESCRIPCIÓN**

**REF.**

**MEDIDAS**

**LEVA**

**ACABADOS**

**UDS**

**B**

**A**

**FRENTE**

**CILINDRO**

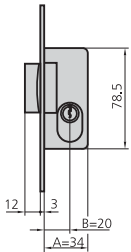

- Picaporte reversible accionado con llave por el exterior y pomo por el interior
- 5979P3030

1979P/0

20

34

HN

CN

1

30

1979P/5

20

34

HN

CL

1

30

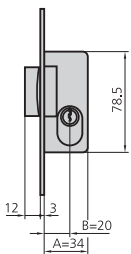

- Picaporte reversible accionado con llave por el exterior y por el interior
- 5979/3030

1979/0

20

34

HN

CN

1

30

1979/5

20

34

HN

CL

1

30

**CARACTERÍSTICAS**

- Cerradura para puertas metálicas enrollables
- Accionamiento exterior e interior mediante llave
- Caja bicromatada
- Cilindro redondo de 3 pitones

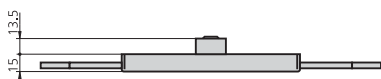
**ACCESORIOS OPCIONALES**

DESCRIPCIÓN	REF.	MEDIDAS		LEVA	ACABADOS		UDS	
		B	A		FRENTE	CILINDRO		
<ul style="list-style-type: none"> <li>• Dos puntos de cierre laterales</li> </ul>	11A	60	154		CL		1	24
<ul style="list-style-type: none"> <li>• Dos puntos de cierre laterales y un punto inferior</li> </ul>	11A/3P	60	154		CL		1	

CERRADURA PARA PUERTAS Y PERSIANAS METÁLICAS ENROLLABLES

SERIE 11E

CARACTERÍSTICAS

- Cerradura para persiana metálica enrollable
- Accionamiento exterior e interior mediante llave
- Cilindro redondo de 3 pitones

ACCESORIOS OPCIONALES

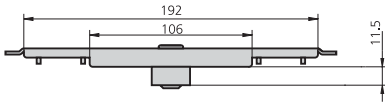

DESCRIPCIÓN	REF.	MEDIDAS		LEVA	ACABADOS		UDS	
		B	A		FRENTE	CILINDRO		
• Dos puntos de cierre horizontales	11E	30	216		CL		1	20

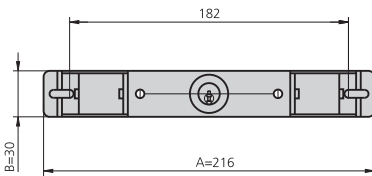

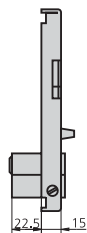

**CARACTERÍSTICAS**

- Accionamiento mediante manilla.
- Bloqueo interior mediante botón, bloqueo exterior mediante llave
- 2 puntos de cierre horizontales
- Caja bicromatada
- Medio cilindro monoblock ref. 5982T40/3
- Opcionalmente con set de escudo y manillas (ref. 11B/M)
- 1 Escudo ref. ES1960

**ACCESORIOS OPCIONALES**

- Gama completa de cilindros (ver páginas 122 - 142)

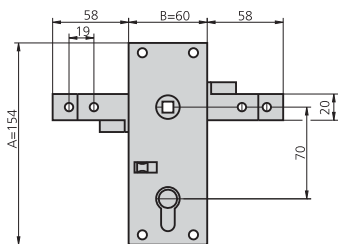
DESCRIPCIÓN	REF.	MEDIDAS		LEVA	ACABADOS		UDS	
		B	A		FRENTE	CILINDRO		
• Dos puntos de cierre horizontales	11B	60	154	15		CL	1	40
• Medio cilindro monoblock 5982T40/3	11B/M	60	154	15		CL	1	40



ACCESORIOS

CERRADEROS PARA CERRADURAS METÁLICAS

DESCRIPCIÓN	REF.	ACABADO	APLICABLE A CERRADURAS	UDS
-------------	------	---------	------------------------	-----

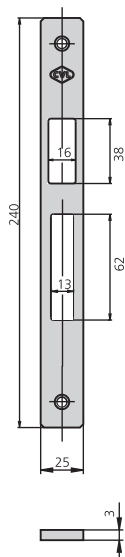

CE1983/0	HN	1983		
CE1983/6	Al			

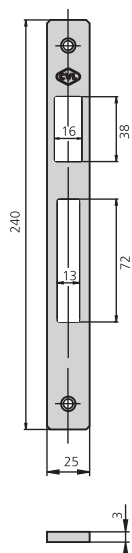

CE1984/0	HN	1984, 1992, 1995,		
CE1984/6	Al	1964, 1963, 1975		

CE1984

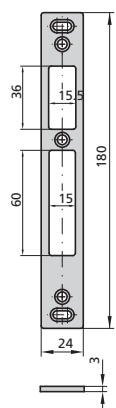

CE190/0	HN	190		
CE190/6	Al	190		

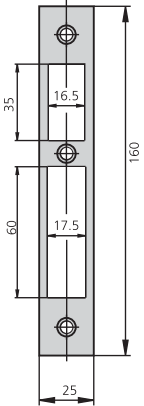
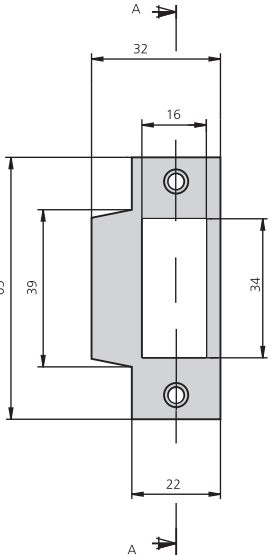
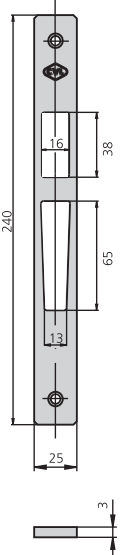
DESCRIPCIÓN	REF.	ACABADO	APLICABLE A CERRADURAS	UDS	
 <p>CE1990</p>	CE1990/0	HN	1990	-----	-----
	CE1991/0	HN	1991, 1981, 11981	-----	-----
	CE1994/6	Al	1994, 2994	-----	-----



ACCESORIOS

CERRADEROS PARA CERRADURAS METÁLICAS

DESCRIPCIÓN	REF.	ACABADO	APLICABLE A CERRADURAS	UDS	
-------------	------	---------	------------------------	-----	--

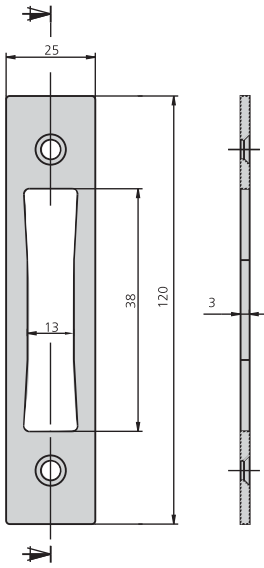

CE2994S/6      Al      1983A, 1963A, 1975A,  
1995A, up/down 2994

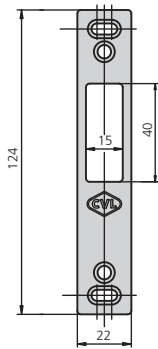

CE196R/6      Al      1963R, 1964R, 1983R,  
1995R

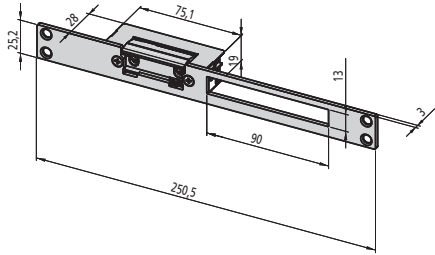
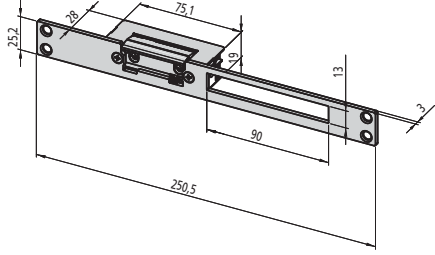
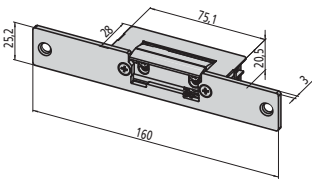
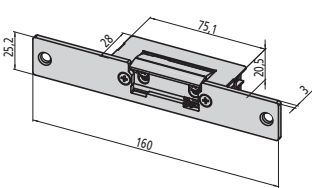
DESCRIPCIÓN	REF.	APLICABLE A CERRADURAS	UDS	
<ul style="list-style-type: none"> <li>• Cerradero eléctrico regulable reversible con funcionamiento automático</li> <li>• Frente plano inox</li> </ul> 	CEL45/6A	1995, 1992, 1984, 190, 1990, 1994, 1983		
<ul style="list-style-type: none"> <li>• Cerradero eléctrico regulable reversible con funcionamiento automático y con desbloqueo</li> <li>• Frente plano inox</li> </ul> 	CEL45/6AD	1995, 1992, 1984, 190, 1990, 1994, 1983		
<ul style="list-style-type: none"> <li>• Cerradero eléctrico regulable reversible con funcionamiento automático</li> <li>• Sólo picaporte y frente plano inox</li> </ul> 	CEL45T/6A	1995T, 1992T, 1983T, 1984T		
<ul style="list-style-type: none"> <li>• Cerradero eléctrico regulable reversible con funcionamiento automático y con desbloqueo</li> <li>• Sólo picaporte y frente plano inox</li> </ul> 	CEL45T/6AD	1995T, 1992T, 1983T, 1984T		



## CERRADURAS DE SOBREPONER

	Cerradura de sobreponer serie 56	88
	• Serie 56A	88
	• Serie 56B	89
	• Serie 56C	90
	Cerradura de sobreponer serie 125	91
	• Serie 125A	91
	• Serie 125B	92
	Cerradura de sobreponer serie 124	93
	• Serie 124A	93
	Cerradura de sobreponer serie 122	94
	• Serie 122A	94
	• Serie 122C	95
	Cerradura de sobreponer serie 123	96
	• Serie 123A	96
	• Serie 123C	97
	Cerrojos	98
• Serie 1976	98	
• Serie 1978	99	
• Serie 1988	100	
Picaportes	101	
• Serie 234	101	
• Serie 236	102	
Cerraderos eléctricos	103	

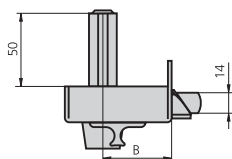

**CARACTERÍSTICAS**

- Picaporte accionado por llave exteriormente y con llave y tirador desde el interior
- Palanca de una vuelta de llave accionable por ambos lados
- Posibilidad de elección entre cilindro de perfil o cilindro redondo
- Dos acabados: hierro esmaltado y hierro niquelado
- Cerradero según cerradura
- Embellecedor según tipo de cilindro
- componentes de sujeción

**ACCESORIOS OPCIONALES**

- Cerraderos eléctricos (ver página 103)
- Cilindro de seguridad

**DESCRIPCIÓN**

**REF.**

**MEDIDAS**

**CILINDRO**

**ACABADOS**  
**FRENTE CILINDRO**

**UDS**



• Cilindro perfil ref. 5056/50/3	56A60D/0	35	60	5056/50/3	HN	CL	1	24
• Cerradero ref. CE56AD o CE56AI	56A60I/0	35	60	5056/50/3	HN	CL	1	24
• Embellecedor ES125	56A60D/1	35	60	5056/50/3	HE	CL	1	24
	56A60I/1	35	60	5056/50/3	HE	CL	1	24
	56A70D/0	45	70	5056/50/3	HN	CL	1	24
<b>Opciones cerraderos eléctricos</b>	56A70I/0	45	70	5056/50/3	HN	CL	1	24
• CELC56/1A o CELC56/1BA	56A70D/1	45	70	5056/50/3	HE	CL	1	24
	56A70I/1	45	70	5056/50/3	HE	CL	1	24

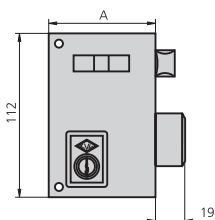

• Cilindro redondo ref. 5156/50/3	156A60D/0	35	60	5156/50/3	HN	CL	1	24
• Cerradero ref. CE56AD o CE56AI	156A60I/0	35	60	5156/50/3	HN	CL	1	24
• Embellecedor ES1125	156A60D/1	35	60	5156/50/3	HE	CL	1	24
	156A60I/1	35	60	5156/50/3	HE	CL	1	24
	156A70D/0	45	70	5156/50/3	HN	CL	1	24
<b>Opciones cerraderos eléctricos</b>	156A70I/0	45	70	5156/50/3	HN	CL	1	24
• CELC56/1A o CELC56/1BA	156A70D/1	45	70	5156/50/3	HE	CL	1	24
	156A70I/1	45	70	5156/50/3	HE	CL	1	24

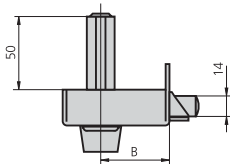

**CARACTERÍSTICAS**

- Picaporte accionado mediante manilla por ambos lados
- Palanca de una vuelta de llave accionable por ambos lados
- Posibilidad de elección entre cilindro de perfil o cilindro redondo
- Dos acabados: hierro esmaltado y hierro niquelado
- Cerradero según cerradura
- Embellecedor según tipo de cilindro
- Componentes de sujeción

**ACCESORIOS OPCIONALES**

- Cerraderos eléctricos (ver página 103)
- Cilindro de seguridad

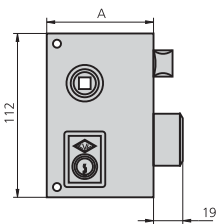
DESCRIPCIÓN	REF.	MEDIDAS		CILINDRO	ACABADOS		UDS	
		B	A		FRENTE	CILINDRO		
• Cilindro perfil ref. 5056/50/3	56B60D/0	35	60	5056/50/3	HN	CL	1	24
• Cerradero ref. CE56AD o CE56AI	56B60I/0	35	60	5056/50/3	HN	CL	1	24
• Embellecedor ES125	56B60D/1	35	60	5056/50/3	HE	CL	1	24
	56B60I/1	35	60	5056/50/3	HE	CL	1	24
<b>Opciones cerraderos eléctricos</b>	56BR70D/0	45	70	5056/50/3	HN	CL	1	24
• CELC56/1A o CELC56/1BA	56BR70I/0	45	70	5056/50/3	HN	CL	1	24
	56BR70D/1	45	70	5056/50/3	HE	CL	1	24
	56BR70I/1	45	70	5056/50/3	HE	CL	1	24



• Cilindro redondo ref. 5156/50/3	156B60D/0	35	60	5156/50/3	HN	CL	1	24
• Cerradero ref. CE56AD o CE56AI	156B60I/0	35	60	5156/50/3	HN	CL	1	24
• Embellecedor ES1125	156B60D/1	35	60	5156/50/3	HE	CL	1	24
	156B60I/1	35	60	5156/50/3	HE	CL	1	24
<b>Opciones cerraderos eléctricos</b>	156BR70D/0	45	70	5156/50/3	HN	CL	1	24
• CELC56/1A o CELC56/1BA	156BR70I/0	45	70	5156/50/3	HN	CL	1	24
	156BR70D/1	45	70	5156/50/3	HE	CL	1	24
	156BR70I/1	45	70	5156/50/3	HE	CL	1	24

CERRADURAS DE SOBREPONER

**CERRADURA DE SOBREPONER SERIE 56**

**SERIE 56C**

**CARACTERÍSTICAS**

- Picaporte accionado por manilla por ambos lados
- Palanca de una vuelta de llave accionable por ambos lados
- Posibilidad de elección entre cilindro de perfil o cilindro redondo
- Dos acabados: hierro esmaltado y hierro niquelado
- Cerradero según cerradura
- Embellecedor según tipo de cilindro
- componentes de sujeción

**ACCESORIOS OPCIONALES**

- Cilindro de seguridad

DESCRIPCIÓN	REF.	MEDIDAS		CILINDRO	ACABADOS		UDS		
		B	A		FRENTE	CILINDRO			
<ul style="list-style-type: none"> <li>• Cilindro perfil ref. 5056/50/3</li> <li>• Cerradero ref. CE56C/1 o CE56C/0</li> <li>• Embellecedor ES125</li> </ul>	56C60D/0	35	60	5056/50/3	HN	CL	1	24	
	56C60I/0	35	60	5056/50/3	HN	CL	1	24	
	56C60D/1	35	60	5056/50/3	HE	CL	1	24	
	56C60I/1	35	60	5056/50/3	HE	CL	1	24	
	56C70D/0	45	70	5056/50/3	HN	CL	1	24	
	56C70I/0	45	70	5056/50/3	HN	CL	1	24	
	56C70D/1	45	70	5056/50/3	HE	CL	1	24	
	56C70I/1	45	70	5056/50/3	HE	CL	1	24	
	<ul style="list-style-type: none"> <li>• Cilindro redondo ref. 5156/50/3</li> <li>• Cerradero ref. CE56C/1 o CE56C/0</li> <li>• Embellecedor ES1125</li> </ul>	156C60D/0	35	60	5156/50/3	HN	CL	1	24
		156C60I/0	35	60	5156/50/3	HN	CL	1	24
156C60D/1		35	60	5156/50/3	HE	CL	1	24	
156C60I/1		35	60	5156/50/3	HE	CL	1	24	
156C70D/0		45	70	5156/50/3	HN	CL	1	24	
156C70I/0		45	70	5156/50/3	HN	CL	1	24	
156C70D/1		45	70	5156/50/3	HE	CL	1	24	
156C70I/1		45	70	5156/50/3	HE	CL	1	24	

- 90 -

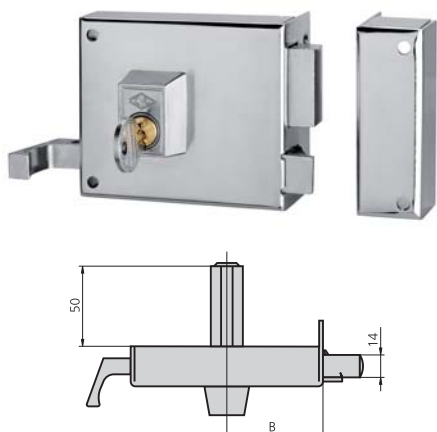
**CARACTERÍSTICAS**

- Picaporte accionado por llave exteriormente y con llave y tirador desde el interior
- Palanca de dos vueltas de llave accionable por ambos lados
- Posibilidad de elección entre cilindro de perfil o cilindro redondo
- Dos acabados: hierro esmaltado y hierro niquelado
- Cerradero según cerradura
- Embellecedor según tipo de cilindro
- Componentes de sujeción

**ACCESORIOS OPCIONALES**

- Cerraderos eléctricos (ver página 103)
- Cilindro de seguridad

DESCRIPCIÓN	REF.	MEDIDAS		CILINDRO	ACABADOS		UDS	
		B	A		FRENTE	CILINDRO		
<ul style="list-style-type: none"> <li>• Cilindro perfil ref. 5056/50/3</li> <li>• Picaporte reversible en la medida de 100 mm (REF. 125AR)</li> <li>• Cerradero ref. CE125AD o CE125AI</li> <li>• Embellecedor ES125</li> </ul> <p><b>Opciones cerraderos eléctricos</b></p> <ul style="list-style-type: none"> <li>• CELC125/1A o CELC125/1BA</li> </ul>	125A8D/0	47	90	5056/50/3	HN	CL	1	20
	125A8I/0	47	90	5056/50/3	HN	CL	1	20
	125A8D/1	47	90	5056/50/3	HE	CL	1	20
	125A8I/1	47	90	5056/50/3	HE	CL	1	20
	125AR10D/0	60	100	5056/50/3	HN	CL	1	20
	125AR10I/0	60	100	5056/50/3	HN	CL	1	20
	125AR10D/1	60	100	5056/50/3	HE	CL	1	20
	125AR10I/1	60	100	5056/50/3	HE	CL	1	20
	125A12D/0	60	120	5056/50/3	HN	CL	1	20
	125A12I/0	60	120	5056/50/3	HN	CL	1	20
	125A12D/1	60	120	5056/50/3	HE	CL	1	20
	125A12I/1	60	120	5056/50/3	HE	CL	1	20
	125A14D/0	70	140	5056/50/3	HN	CL	1	20
	125A14I/0	70	140	5056/50/3	HN	CL	1	20
125A14D/1	70	140	5056/50/3	HE	CL	1	20	
125A14I/1	70	140	5056/50/3	HE	CL	1	20	
<ul style="list-style-type: none"> <li>• Cilindro redondo ref. 5156/50/3</li> <li>• Picaporte reversible en la medida de 100 mm (REF. 1125AR)</li> <li>• Cerradero ref. CE125AD o CE125AI</li> <li>• Embellecedor ES1125</li> </ul> <p><b>Opciones cerraderos eléctricos</b></p> <ul style="list-style-type: none"> <li>• CELC125/1A o CELC125/1BA</li> </ul>	1125A8D/0	47	90	5156/50/3	HN	CL	1	20
	1125A8I/0	47	90	5156/50/3	HN	CL	1	20
	1125A8D/1	47	90	5156/50/3	HE	CL	1	20
	1125A8I/1	47	90	5156/50/3	HE	CL	1	20
	1125AR10D/0	60	100	5156/50/3	HN	CL	1	20
	1125AR10I/0	60	100	5156/50/3	HN	CL	1	20
	1125AR10D/1	60	100	5156/50/3	HE	CL	1	20
	1125AR10I/1	60	100	5156/50/3	HE	CL	1	20
	1125A12D/0	60	120	5156/50/3	HN	CL	1	20
	1125A12I/0	60	120	5156/50/3	HN	CL	1	20
	1125A12D/1	60	120	5156/50/3	HE	CL	1	20
	1125A12I/1	60	120	5156/50/3	HE	CL	1	20
	1125A14D/0	70	140	5156/50/3	HN	CL	1	20
	1125A14I/0	70	140	5156/50/3	HN	CL	1	20
1125A14D/1	70	140	5156/50/3	HE	CL	1	20	
1125A14I/1	70	140	5156/50/3	HE	CL	1	20	



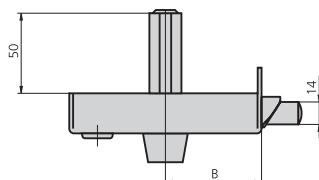

**CARACTERÍSTICAS**

- Picaporte accionado por manilla por ambos lados
- Picaporte reversible
- Palanca de dos vueltas de llave accionable por ambos lados
- Posibilidad de elección entre cilindro de perfil o cilindro redondo
- Dos acabados: hierro esmaltado y hierro niquelado
- Cerradero según cerradura
- Embellecedor según tipo de cilindro
- Componentes de sujeción

**ACCESORIOS OPCIONALES**

- Cerraderos eléctricos (ver página 103)
- Cilindro de seguridad

DESCRIPCIÓN	REF.	MEDIDAS		CILINDRO	ACABADOS		UDS	
		B	A		FRENTE	CILINDRO		
• Cilindro perfil ref. 5056/50/3	125BR12D/0	60	120	5056/50/3	HN	CL	1	24
• Picaporte reversible	125BR12I/0	60	120	5056/50/3	HN	CL	1	24
• Cerradero ref. CE125AD o CE125AI	125BR12D/1	60	120	5056/50/3	HE	CL	1	24
• Embellecedor ES125	125BR12I/1	60	120	5056/50/3	HE	CL	1	24
<b>Opciones cerraderos eléctricos</b>	125BR14D/0	70	140	5056/50/3	HN	CL	1	24
• CELC125/1A o CELC125/1BA	125BR14I/0	70	140	5056/50/3	HN	CL	1	24
	125BR14D/1	70	140	5056/50/3	HE	CL	1	24
	125BR14I/1	70	140	5056/50/3	HE	CL	1	24

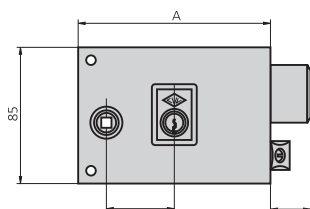

- Cilindro redondo ref. 5156/50/3
- Picaporte reversible
- Cerradero ref. CE125AD o CE125AI
- Embellecedor ES1125

**Opciones cerraderos eléctricos**

- CELC125/1A o CELC125/1BA

1125BR12D/0	60	120	5156/50/3	HN	CL	1	24
1125BR12I/0	60	120	5156/50/3	HN	CL	1	24
1125BR12D/1	60	120	5156/50/3	HE	CL	1	24
1125BR12I/1	60	120	5156/50/3	HE	CL	1	24
1125BR14D/0	70	140	5156/50/3	HN	CL	1	24
1125BR14I/0	70	140	5156/50/3	HN	CL	1	24
1125BR14D/1	70	140	5156/50/3	HE	CL	1	24
1125BR14I/1	70	140	5156/50/3	HE	CL	1	24

**CARACTERÍSTICAS**

- Palanca de dos vueltas de llave accionable por ambos lados
- Posibilidad de elección entre cilindro de perfil o cilindro redondo
- Dos acabados: hierro esmaltado y hierro niquelado
- Cerradero según cerradura
- Embellecedor según tipo de cilindro
- Componentes de sujeción

**ACCESORIOS OPCIONALES**

- Cilindro de seguridad

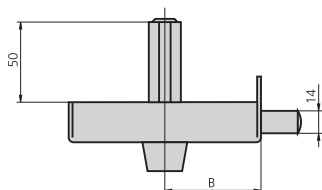
**DESCRIPCIÓN**
**REF.**
**MEDIDAS**
**CILINDRO**
**ACABADOS**  
**FRENTE CILINDRO**
**UDS**

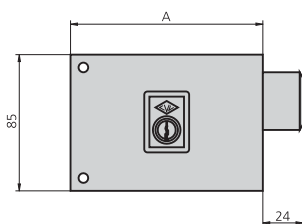

- Cilindro perfil ref. 5056/50/3
- Cerradero ref. CE125AD o CE125AI
- Embellecedor ES125

		B	A					
	124A8D/0	47	90	5056/50/3	HN	CL	1	24
	124A8I/0	47	90	5056/50/3	HN	CL	1	24
	124A8D/1	47	90	5056/50/3	HE	CL	1	24
	124A8I/1	47	90	5056/50/3	HE	CL	1	24
	124A10D/0	60	100	5056/50/3	HN	CL	1	24
	124A10I/0	60	100	5056/50/3	HN	CL	1	24
	124A10D/1	60	100	5056/50/3	HE	CL	1	24
	124A10I/1	60	100	5056/50/3	HE	CL	1	24
	124A12D/0	60	120	5056/50/3	HN	CL	1	24
	124A12I/0	60	120	5056/50/3	HN	CL	1	24
	124A12D/1	60	120	5056/50/3	HE	CL	1	24
	124A12I/1	60	120	5056/50/3	HE	CL	1	24
	124A14D/0	70	140	5056/50/3	HN	CL	1	24
	124A14I/0	70	140	5056/50/3	HN	CL	1	24
	124A14D/1	70	140	5056/50/3	HE	CL	1	24
	124A14I/1	70	140	5056/50/3	HE	CL	1	24

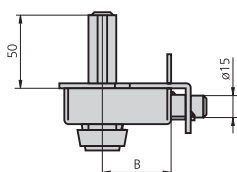

- Cilindro redondo ref. 5156/50/3
- Cerradero ref. CE125AD o CE125AI
- Embellecedor ES1125

	1124A8D/0	47	90	5156/50/3	HN	CL	1	24
	1124A8I/0	47	90	5156/50/3	HN	CL	1	24
	1124A8D/1	47	90	5156/50/3	HE	CL	1	24
	1124A8I/1	47	90	5156/50/3	HE	CL	1	24
	1124A10D/0	60	100	5156/50/3	HN	CL	1	24
	1124A10I/0	60	100	5156/50/3	HN	CL	1	24
	1124A10D/1	60	100	5156/50/3	HE	CL	1	24
	1124A10I/1	60	100	5156/50/3	HE	CL	1	24
	1124A12D/0	60	120	5156/50/3	HN	CL	1	24
	1124A12I/0	60	120	5156/50/3	HN	CL	1	24
	1124A12D/1	60	120	5156/50/3	HE	CL	1	24
	1124A12I/1	60	120	5156/50/3	HE	CL	1	24
	1124A14D/0	70	140	5156/50/3	HN	CL	1	24
	1124A14I/0	70	140	5156/50/3	HN	CL	1	24
	1124A14D/1	70	140	5156/50/3	HE	CL	1	24
	1124A14I/1	70	140	5156/50/3	HE	CL	1	24



**CARACTERÍSTICAS**

- Cerradura de sobreponer reforzada
- Picaporte accionado por llave exteriormente y con llave o pomo desde el interior
- Palanca de 3 bulones de acero a dos vueltas de llave accionable por ambos lados del cilindro
- Sistema antipalanqueta
- Posibilidad de elección entre cilindro de perfil o cilindro redondo
- Dos acabados: hierro esmaltado y hierro niquelado
- Cerradero según cerradura
- Embellecedor según tipo de cilindro
- Componentes de sujeción

**ACCESORIOS OPCIONALES**

- Cilindro de seguridad

**DESCRIPCIÓN**

**REF.**

**MEDIDAS  
B A**

**CILINDRO**

**ACABADOS  
FRENTE CILINDRO**

**UDS**



- Cilindro perfil ref. 5056/50/3
- Cerradero ref. CE122AD o CE122AI
- Embellecedor ES125

122A70D/0	45	70	5056/50/3	HN	CL	1	10
122A70I/0	45	70	5056/50/3	HN	CL	1	10
122A70D/1	45	70	5056/50/3	HE	CL	1	10
122A70I/1	45	70	5056/50/3	HE	CL	1	10

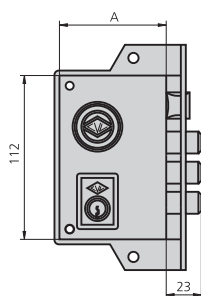

- Cilindro redondo ref. 5156/50/3
- Cerradero ref. CE122AD o CE122AI
- Embellecedor ES1125

1122A70D/0	45	70	5156/50/3	HN	CL	1	10
1122A70I/0	45	70	5156/50/3	HN	CL	1	10
1122A70D/1	45	70	5156/50/3	HE	CL	1	10
1122A70I/1	45	70	5156/50/3	HE	CL	1	10

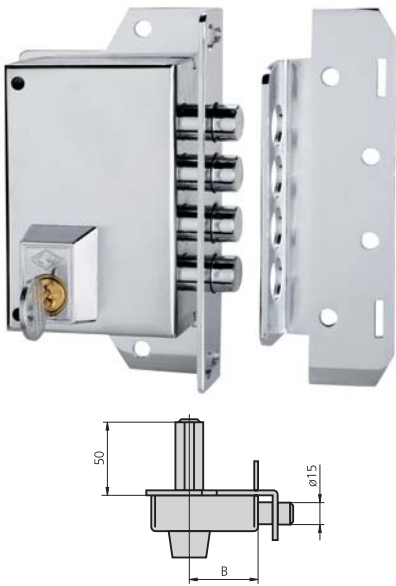
**CARACTERÍSTICAS**

- Cerradura de sobreponer reforzada
- Palanca de 4 bulones de acero a dos vueltas de llave accionable por ambos lados del cilindro
- Sistema antipalanqueta
- Posibilidad de elección entre cilindro de perfil o cilindro redondo
- Dos acabados: hierro esmaltado y hierro niquelado
- Cerradero según cerradura
- Embellecedor según tipo de cilindro
- Componentes de sujeción

**ACCESORIOS OPCIONALES**

- Cilindro de seguridad

DESCRIPCIÓN	REF.	MEDIDAS		CILINDRO	ACABADOS		UDS	
		B	A		FRENTE	CILINDRO		
<ul style="list-style-type: none"> <li>• Cilindro perfil ref. 5056/50/3</li> <li>• Cerradero ref. CE122C/1 o CE122C/0</li> <li>• Embellecedor ES125</li> </ul>	122C70D/0	45	70	5056/50/3	HN	CL	1	10
	122C70I/0	45	70	5056/50/3	HN	CL	1	10
	122C70D/1	45	70	5056/50/3	HE	CL	1	10
	122C70I/1	45	70	5056/50/3	HE	CL	1	10
<ul style="list-style-type: none"> <li>• Cilindro redondo ref. 5156/50/3</li> <li>• Cerradero ref. CE122C/1 o CE122C/0</li> <li>• Embellecedor ES1125</li> </ul>	1122C70D/0	45	70	5156/50/3	HN	CL	1	10
	1122C70I/0	45	70	5156/50/3	HN	CL	1	10
	1122C70D/1	45	70	5156/50/3	HE	CL	1	10
	1122C70I/1	45	70	5156/50/3	HE	CL	1	10

**CERRADURA DE SOBREPONER SERIE 123**

**SERIE 123A**

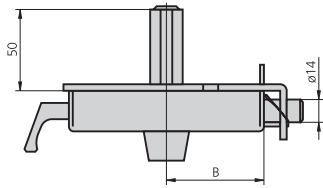

**CARACTERÍSTICAS**

- Cerradura de sobreponer reforzada
- Picaporte accionable mediante llave por el exterior y con tirador o llave desde el interior
- Palanca de 3 bulones de acero a dos vueltas de llave accionable por ambos lados del cilindro
- Sistema antipalanqueta
- Posibilidad de elección entre cilindro de perfil o cilindro redondo
- Dos acabados: hierro esmaltado y hierro niquelado
- Cerradero según cerradura
- Embellecedor según tipo de cilindro
- Componentes de sujeción

**ACCESORIOS OPCIONALES**

- Cilindro de seguridad

DESCRIPCIÓN	REF.	MEDIDAS		CILINDRO	ACABADOS		UDS	
		B	A		FRENTE	CILINDRO		
• Cilindro perfil ref. 5056/50/3	123A10D/0	60	100	5056/50/3	HN	CL	1	10
• Cerradero ref. CE123AD o CE123AI	123A10I/0	60	100	5056/50/3	HN	CL	1	10
• Embellecedor ES125	123A10D/1	60	100	5056/50/3	HE	CL	1	10
	123A10I/1	60	100	5056/50/3	HE	CL	1	10
	123A12D/0	60	120	5056/50/3	HN	CL	1	10
	123A12I/0	60	120	5056/50/3	HN	CL	1	10
	123A12D/1	60	120	5056/50/3	HE	CL	1	10
	123A12I/1	60	120	5056/50/3	HE	CL	1	10

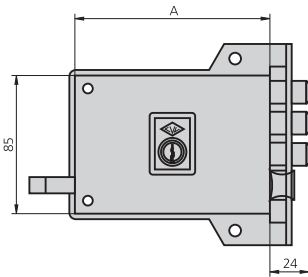

- Cilindro redondo ref. 5156/50/3
- Cerradero ref. CE123AD o CE123AI
- Embellecedor ES1125

	1123A10D/0	60	100	5156/50/3	HN	CL	1	10
	1123A10I/0	60	100	5156/50/3	HN	CL	1	10
	1123A10D/1	60	100	5156/50/3	HE	CL	1	10
	1123A10I/1	60	100	5156/50/3	HE	CL	1	10
	1123A12D/0	60	120	5156/50/3	HN	CL	1	10
	1123A12I/0	60	120	5156/50/3	HN	CL	1	10
	1123A12D/1	60	120	5156/50/3	HE	CL	1	10
	1123A12I/1	60	120	5156/50/3	HE	CL	1	10

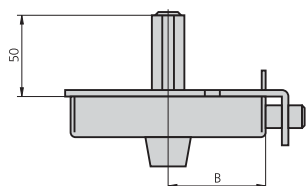

**CARACTERÍSTICAS**

- Cerradura de sobreponer reforzada
- Palanca de 4 bulones de acero a dos vueltas de llave accionable por ambos lados del cilindro
- Sistema antipalanqueta
- Posibilidad de elección entre cilindro de perfil o cilindro redondo
- Dos acabados: hierro esmaltado y hierro niquelado
- Cerradero según cerradura
- Embellecedor según tipo de cilindro
- Componentes de sujeción

**ACCESORIOS OPCIONALES**

- Cilindro de seguridad

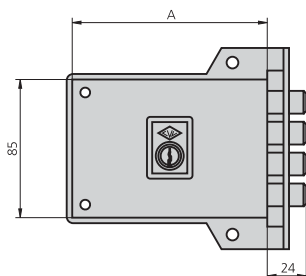
DESCRIPCIÓN	REF.	MEDIDAS		CILINDRO	ACABADOS		UDS	
		B	A		FRENTE	CILINDRO		
• Cilindro perfil ref. 5056/50/3	123C10D/0	60	100	5056/50/3	HN	CL	1	10
• Cerradero ref. CE123C/1 o CE123C/1	123C10I/0	60	100	5056/50/3	HN	CL	1	10
• Embellecedor ES125	123C10D/1	60	100	5056/50/3	HE	CL	1	10
	123C10I/1	60	100	5056/50/3	HE	CL	1	10
	123C12D/0	60	120	5056/50/3	HN	CL	1	10
	123C12I/0	60	120	5056/50/3	HN	CL	1	10
	123C12D/1	60	120	5056/50/3	HE	CL	1	10
	123C12I/1	60	120	5056/50/3	HE	CL	1	10



- Cilindro redondo ref. 5156/50/3
- Cerradero ref. CE123C/1 o CE123C/1
- Embellecedor ES1125

	1123C10D/0	60	100	5156/50/3	HN	CL	1	10
	1123C10I/0	60	100	5156/50/3	HN	CL	1	10
	1123C10D/1	60	100	5156/50/3	HE	CL	1	10
	1123C10I/1	60	100	5156/50/3	HE	CL	1	10
	1123C12D/0	60	120	5156/50/3	HN	CL	1	10
	1123C12I/0	60	120	5156/50/3	HN	CL	1	10
	1123C12D/1	60	120	5156/50/3	HE	CL	1	10
	1123C12I/1	60	120	5156/50/3	HE	CL	1	10

CARACTERÍSTICAS

- Cerrojo de seguridad reversible aplicable a puertas metálicas basculantes o enrollables
- Se suministra por parejas con la misma llave
- Palanca deslizante de acero accionable por llave desde el exterior
- Cilindro exterior redondo diámetro 26 mm
- Acabado en hierro esmaltado

ACCESORIOS OPCIONALES

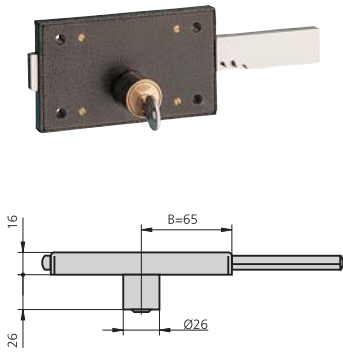

DESCRIPCIÓN

REF.

MEDIDAS

CILINDRO

ACABADOS

UDS

B

A

FRENTE CILINDRO

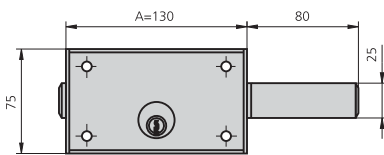

1976/1

65

130

Ø 26mm

HE

CL

1

17

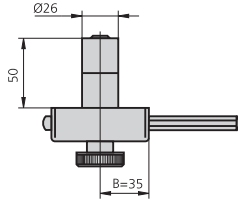
**CARACTERÍSTICAS**

- Cerrojo de seguridad reversible
- Palanca deslizante de acero accionable por llave desde el exterior y mediante pomo desde el interior
- Cilindro exterior redondo diámetro 26 mm
- Dos acabados: hierro esmaltado y hierro niquelado
- Cerradero CE1978/1 o CE1978/0
- Embellecedor ES1125
- Componentes de sujeción

**ACCESORIOS OPCIONALES**

- Cilindro de seguridad
- Cilindros de distintas larguras

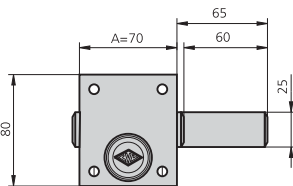
**DESCRIPCIÓN**
**REF.**
**MEDIDAS**
**CILINDRO**
**ACABADOS**
**UDS**
**B**
**A**
**FRENTE CILINDRO**

1978/0	35	70	Ø 26mm	HN	CL	1	20
1978/1	35	70	Ø 26mm	HE	CL	1	20



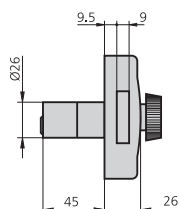

**CARACTERÍSTICAS**

- Cerrojo de seguridad reversible
- Palanca deslizante de acero accionable por llave desde el exterior y mediante pomo desde el interior
- Cilindro exterior redondo diámetro 26 mm
- Dos acabados: hierro esmaltado y hierro niquelado
- Cerradero CE1988/1 o CE1988/0
- Embellecedor ES1125
- Componentes de sujeción

**ACCESORIOS OPCIONALES**

- Cilindro de seguridad
- Cilindros de distintas longitudes

**DESCRIPCIÓN**

**REF.**

**MEDIDAS  
B A**

**CILINDRO**

**ACABADOS  
FRENTE CILINDRO**

**UDS**

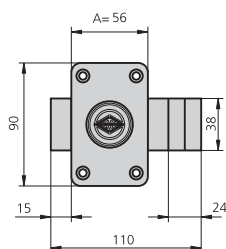

1988/0	56	Ø 26mm	HN	CL	1	24
1988/1	56	Ø 26mm	HE	CL	1	24

**PICAPORTES**

**SERIE 234**

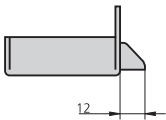

**CARACTERÍSTICAS**

- Picaporte reversible de sobreponer
- Picaporte accionable mediante manilla
- Cuadradillo para manilla de 8 mm
- Acabado en hierro esmaltado
- Cerradero CE234/1
- Embellecedor ES234

**ACCESORIOS OPCIONALES**



DESCRIPCIÓN	REF.	MEDIDAS		CILINDRO	ACABADOS		UDS	
		B	A		FRENTE	CILINDRO		

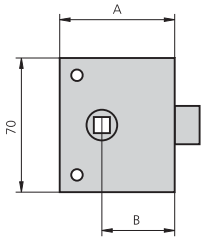

234/50/1	30	50	-	HE		6	120
234/60/1	38	60	-	HE		6	120
234/70/1	46	70	-	HE		6	120

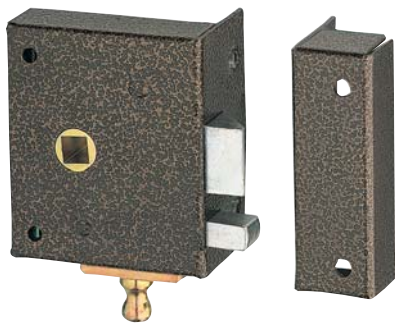

**CARACTERÍSTICAS**

- Picaporte reversible de sobreponer
- Condena accionable mediante tirador
- Cuadradillo para manilla de 8 mm
- Acabado en hierro esmaltado
- Cerradero CE236/1
- Embellecedor ES234

**ACCESORIOS OPCIONALES**

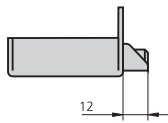

**DESCRIPCIÓN**

**REF.**

**MEDIDAS**

**CILINDRO**

**ACABADOS**

**UDS**

**B**

**A**

**FRENTE**

**CILINDRO**

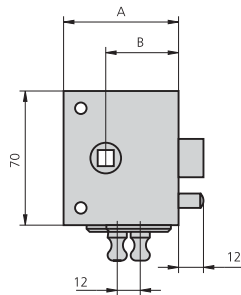

236/50/1

30

50

-

HE

6

120

236/60/1

38

60

-

HE

6

120

236/70/1

46

70

-

HE

6

120

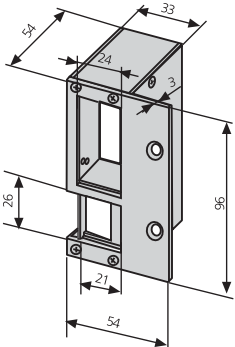
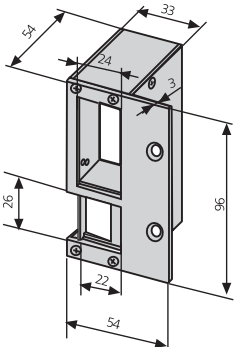
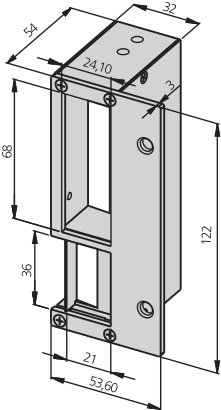
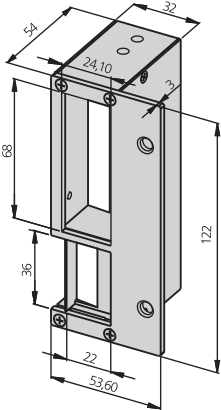
DESCRIPCIÓN	REF.	PARA
 <ul style="list-style-type: none"> <li>Cerradero eléctrico reversible de 96 mm con sujeción oculta para cerraduras horizontales con cerrojo (RF. 125) que tengan un espesor de 20 mm</li> </ul>	CELC125/1A	125, 1125
 <ul style="list-style-type: none"> <li>Cerradero eléctrico reversible de 96 mm con sujeción oculta para cerraduras horizontales con cerrojo (RF. 125) que tengan un espesor superior a 20 mm</li> </ul>	CELC125/1BA	125, 1125
 <ul style="list-style-type: none"> <li>Cerradero eléctrico reversible de 122 mm con sujeción oculta para cerraduras horizontales con cerrojo (ref. 56) que tengan un espesor de 20 mm</li> </ul>	CELC56/1A	56, 156
 <ul style="list-style-type: none"> <li>Cerradero eléctrico reversible de 122 mm con sujeción oculta para cerraduras horizontales con cerrojo (ref. 56) que tengan un espesor superior a 20 mm</li> </ul>	CELC56/1BA	56, 156



## CERRADURAS DE EMBUTIR PARA CARPINTERÍA DE MADERA

<b>Cerraduras de seguridad con palanca de bulones</b>	<b>106</b>
• Serie 4000	106
<b>Cerradura multipunto de seguridad con palanca de bulones</b>	<b>107</b>
• Serie 4100	107
<b>Cerraduras de palanca rectangular deslizante</b>	<b>108</b>
• Serie 1985	108
• Serie 1970	109
• Serie 1960	111
• Serie 1961	112
• Serie 1962	113
• Serie 62 y 63R	114
<b>Picaportes</b>	<b>115</b>
• Serie 943	115
• Serie 942	116
• Serie 249	117
<b>Accesorios</b>	<b>118</b>
• Cerraderos para cerraduras para puertas de madera	118
• Escudos	120
• Escudos de seguridad	120

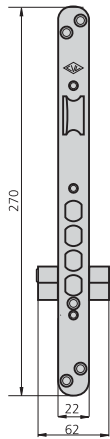

**CARACTERÍSTICAS**

- Cerradura de seguridad de 1 punto y palanca de 4 bulones de acero
- Entre ejes 85 mm
- Frente de hierro latonado o acero inoxidable disponible en canto redondo y canto cuadrado
- Picaporte reversible accionable mediante llave y manilla
- Cerradero de hierro latonado o acero inoxidable disponible en canto redondo y canto cuadrado
- Escudo protector de cilindro
- Cilindro de seguridad
- Otros acabados posibles: inox, pintado bronce ingles, pintado dorado, pintado plateado

**ACCESORIOS OPCIONALES**

- Gama completa de cilindros (ver páginas 122 - 142)

**DESCRIPCIÓN**

**REF.**

**MEDIDAS  
B A**

**LEVA**

**ACABADOS  
FRENTE CILINDRO**

**CANTO**



**UDS**



• Picaporte y palanca de 4 bulones de acero	4000/50/0	50	80	15	HN	CN	Red	1	12
	4001/50/0	50	80	15	HN	CN	Cua	1	12
• Cilindro de seguridad 6982/2525	4000/60/0	60	90	15	HN	CN	Red	1	12
	4001/60/0	60	90	15	HN	CN	Cua	1	12

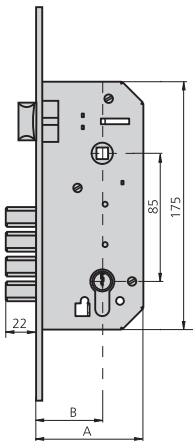

• Cerradura con sólo palanca de 4 bulones de acero	4000A50/0	50	80	15	HN	CN	Red	1	12
	4001A50/0	50	80	15	HN	CN	Cua	1	12
• Cilindro de seguridad 6982/2525	4000A60/0	60	90	15	HN	CN	Red	1	12
	4001A60/0	60	90	15	HN	CN	Cua	1	12

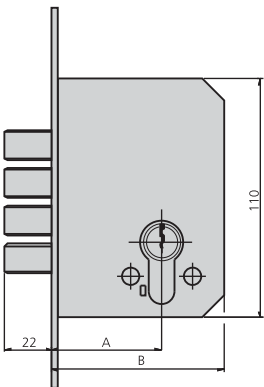

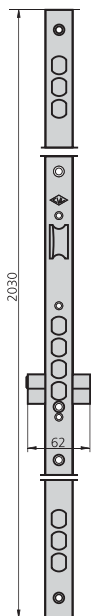
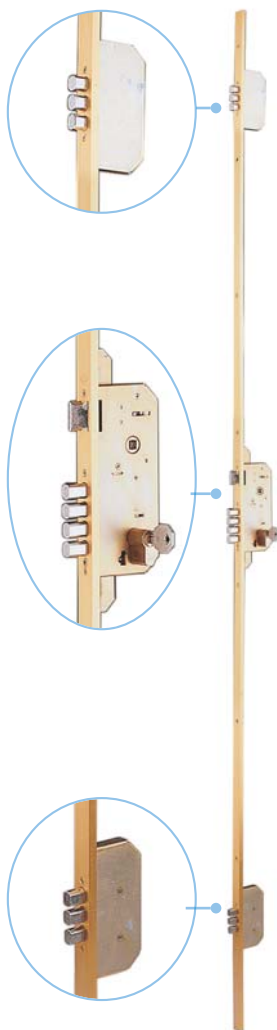
**CARACTERÍSTICAS**

- Cerradura de alta seguridad de 3 puntos de cierre mediante 10 bulones de acero
- Entre ejes 85 mm
- Frente largo de acero pintado dorado
- Picaporte reversible accionable mediante llave y manilla
- 3 cerraderos cortos de acero pintado dorado
- Escudo protector de cilindro de seguridad pintado dorado
- Cilindro de seguridad
- Otros acabados posibles: inox, pintado bronce ingles, pintado dorado, pintado plateado

**ACCESORIOS OPCIONALES**

- Gama completa de cilindros (ver páginas 122 - 142)

DESCRIPCIÓN	REF.	MEDIDAS		LEVA	ACABADOS		UDS	
		B	A		FRENTE	CILINDRO		

- Cerradura de 3 puntos ref. 4100/50/0
- Cilindro de seguridad ref. 6982/2525/3

4100/50/0	50	80	15	HN		1	
4100/60/0	60	90	15	HN		1	

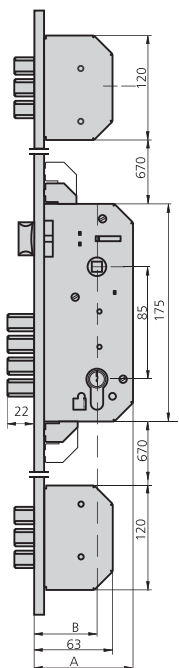



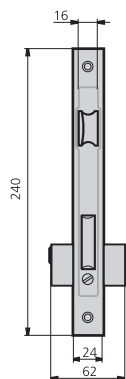

**CARACTERÍSTICAS**

- Entre ejes 85 mm
- Frente de hierro latonado o acero inoxidable
- Picaporte reversible accionable mediante llave y manilla
- Palanca deslizante a dos vueltas de llave
- Cerradero según cerradura
- Embellecedor ES1960
- Componentes de sujeción
- Cilindro europerfil

**ACCESORIOS OPCIONALES**

- Gama completa de cilindros (ver páginas 122 - 142)

**DESCRIPCIÓN**

**REF.**

**MEDIDAS**

**LEVA**

**ACABADOS**  
FRENTE CILINDRO

**UDS**



**B**

**A**

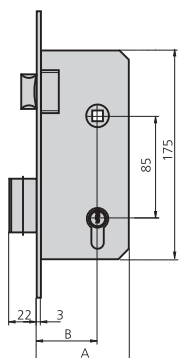

- Cerradura con resbalón y palanca
- Cilindro de leva larga 5982/2525
- Cerradero CE1985/2 o CE1985/6

1985/40/2	40	68	15	HL	CL	1	12
1985/40/6	40	68	15	AI	CN	1	12
1985/50/2	50	78	15	HL	CL	1	12
1985/50/6	50	78	15	AI	CN	1	12
1985/60/2	60	88	15	HL	CL	1	12
1985/60/6	60	88	15	AI	CN	1	12

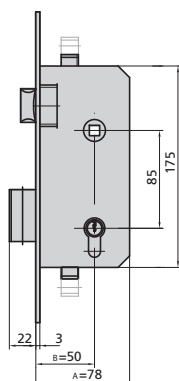

- Cerradura con picaporte y palanca
- 3 puntos de cierre
- Cilindro de leva larga 5982/2525
- Cerradero CE1985/2 o CE1985/6

1985/3P/2	50	78	15	HL	CL	1	12
-----------	----	----	----	----	----	---	----

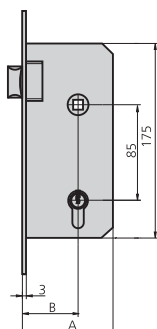

- Cerradura de sólo picaporte
- Con medio cilindro 5982T40
- Cerradero CE1970R/2 o CE1970R/6

1985T40/2	40	68	15	HL	CL	1	12
1985T40/6	40	68	15	AI	CN	1	12
1985T50/2	50	78	15	HL	CL	1	12
1985T50/6	50	78	15	AI	CN	1	12
1985T60/2	60	88	15	HL	CL	1	12
1985T60/6	60	88	15	AI	CN	1	12

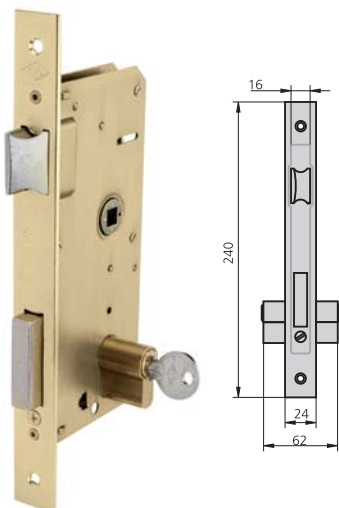

**CARACTERÍSTICAS**

- Entre ejes 70 mm
- Frente de hierro latonado o acero inoxidable
- Picaporte reversible accionable mediante llave y manilla
- Palanca deslizante a dos vueltas de llave
- Cerradero según cerradura
- Embellecedor ES1960
- Componentes de sujeción
- Cilindro europerfil

**ACCESORIOS OPCIONALES**

- Gama completa de cilindros (ver páginas 122 - 142)

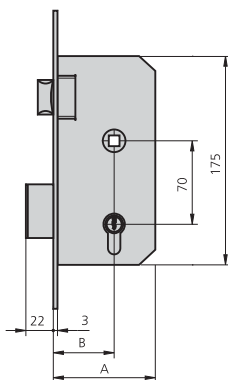
DESCRIPCIÓN	REF.	MEDIDAS		LEVA	ACABADOS		UDS	
		B	A		FRENTE	CILINDRO		



- Cerradura con picaporte y palanca
- Cilindro de leva larga 5982/2525
- Cerradero CE1985/2 o CE1985/6

1970/40/2	40	68	15	HL	CL	1	12
1970/40/6	40	68	15	AI	CN	1	12
1970/50/2	50	78	15	HL	CL	1	12
1970/50/6	50	78	15	AI	CN	1	12
1970/60/2	60	88	15	HL	CL	1	12
1970/60/6	60	88	15	AI	CN	1	12

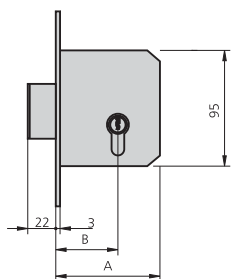

- Cerradura con sólo palanca
- Cilindro de leva larga 5982/2525
- Cerradero CE1970A/2 o CE1970A/6

1970A40/2	40	68	15	HL	CL	1	20
1970A40/6	40	68	15	AI	CN	1	20
1970A50/2	50	78	15	HL	CL	1	20
1970A50/6	50	78	15	AI	CN	1	20
1970A60/2	60	88	15	HL	CL	1	20
1970A60/6	60	88	15	AI	CN	1	20

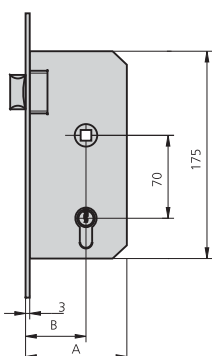



- Cerradura de sólo picaporte
- Con medio cilindro 5982T40
- Cerradero CE1970R/2 o CE1970R/6

1970T40/2	40	68	15	HL	CL	1	12
1970T40/6	40	68	15	AI	CN	1	12
1970T50/2	50	78	15	HL	CL	1	12
1970T50/6	50	78	15	AI	CN	1	12
1970T60/2	60	88	15	HL	CL	1	12
1970T60/6	60	88	15	AI	CN	1	12

## CERRADURAS DE PALANCA RECTANGULAR DESLIZANTE

## SERIE 1970

DESCRIPCIÓN	REF.	MEDIDAS		LEVA	ACABADOS		UDS	
		B	A		FRENTE	CILINDRO		
• Cerradura con rodillo y palanca	1970V40/2	40	68	15	HL	CL	1	12
	1970V40/6	40	68	15	AI	CN	1	12
• Con cilindro 5982/2525	1970V50/2	50	78	15	HL	CL	1	12
	1970V50/6	50	78	15	AI	CN	1	12
• Cerradero CE1985/2 o CE1985/6	1970V60/2	60	88	15	HL	CL	1	12
	1970V60/6	60	88	15	AI	CN	1	12

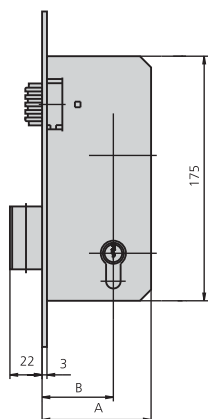

- Cerradura con rodillo y palanca
- Con cilindro 5982/2525
- Cerradero CE1985/2 o CE1985/6

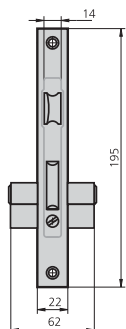

**CARACTERÍSTICAS**

- Entre ejes 48 mm
- Frente de hierro latonado o acero inoxidable
- Picaporte reversible accionable mediante llave y manilla
- Palanca deslizante accionado por una vuelta de llave
- Cerradero según cerradura
- Embellecedor ES1960
- Componentes de sujeción
- Cilindro europerfil

**ACCESORIOS OPCIONALES**

- Gama completa de cilindros (ver páginas 122 - 142)

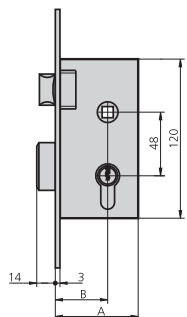
DESCRIPCIÓN	REF.	MEDIDAS		LEVA	ACABADOS		UDS	
		B	A		FRENTE	CILINDRO		



- Cerradura con picaporte y palanca
- Cilindro de leva larga 5982/2525
- Cerradero CE1960/2 o CE1960/6

1960/60/2	40	62	15	HL	CL	1	20
1960/60/6	40	62	15	AI	CN	1	20
1960/70/2	50	72	15	HL	CL	1	20
1960/70/6	50	72	15	AI	CN	1	20

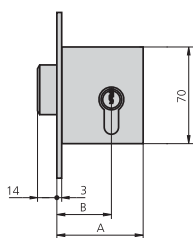

- Cerradura con sólo palanca
- Cilindro de leva larga 5982/2525
- Cerradero CE1960A/2 o CE1960A/6

1960A60/2	40	62	15	HL	CL	1	30
1960A60/6	40	62	15	AI	CN	1	30
1960A70/2	50	72	15	HL	CL	1	30
1960A70/6	50	72	15	AI	CN	1	30

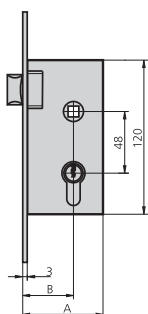

- Cerradura de sólo picaporte
- Con medio cilindro 5982T40
- Cerradero CE249R/2 o CE249R/6

1960T60/2	40	62	15	HL	CL	1	20
1960T60/6	40	62	15	AI	CN	1	20
1960T70/2	50	72	15	HL	CL	1	20
1960T70/6	50	72	15	AI	CN	1	20

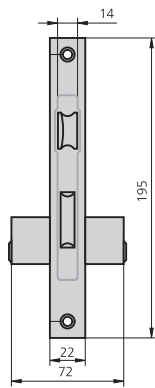

**CARACTERÍSTICAS**

- Frente de hierro latonado
- Picaporte reversible accionable mediante llave y manilla
- Palanca deslizante accionado por llave
- Cerradero según cerradura
- Embellecedor ES1964
- Componentes de sujeción
- Cilindro ovalado 5961/2525/3

**ACCESORIOS OPCIONALES**

- Gama completa de cilindros (ver páginas 122 - 142)

**DESCRIPCIÓN**

**REF.**

**MEDIDAS**

**LEVA**

**ACABADOS**

**UDS**

**B**

**A**

**FRENTE**

**CILINDRO**

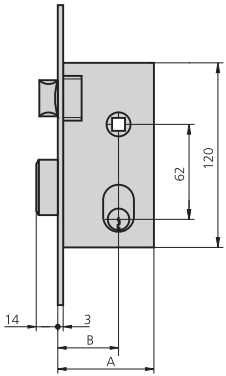

- Cerradura con picaporte y palanca
- Cerradero CE1960/2

1961/60/2

40

62

HL

CL

1

20

1961/70/2

50

72

HL

CL

1

20

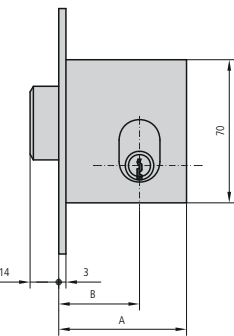

- Cerradura con sólo palanca
- Cerradero CE1960A/2

1961A60/2

40

62

HL

CL

1

20

1961A70/2

50

72

HL

CL

1

20

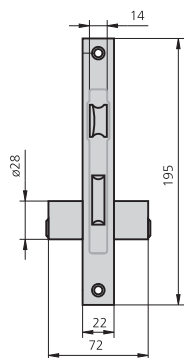

**CARACTERÍSTICAS**

- Frente de hierro latonado
- Picaporte reversible accionable mediante llave y manilla
- Palanca deslizante accionado por llave
- Cerradero según cerradura
- Embellecedor ES1962
- Componentes de sujeción
- Cilindro redondo

**ACCESORIOS OPCIONALES**

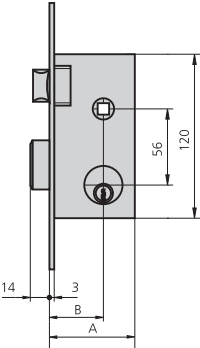
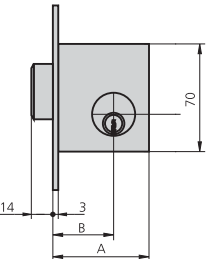
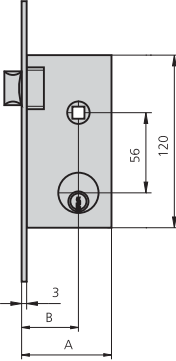
- Gama completa de cilindros (ver páginas 122 - 142)

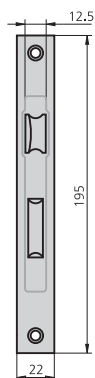
DESCRIPCIÓN	REF.	MEDIDAS		LEVA	ACABADOS		UDS	
		B	A		FRENTE	CILINDRO		
 <ul style="list-style-type: none"> <li>• Cerradura con picaporte y palanca</li> <li>• Cilindro redondo 5962/2525/3</li> <li>• Cerradero CE1960/2</li> </ul>	1962/60/2	40	62		HL	CL	1	20
	1962/70/2	50	72		HL	CL	1	20
 <ul style="list-style-type: none"> <li>• Cerradura con sólo palanca</li> <li>• Cilindro redondo 5962/2525/3</li> <li>• Cerradero CE1960A/2</li> </ul>	1962A60/2	40	62		HL	CL	1	30
	1962A70/2	50	72		HL	CL	1	30
 <ul style="list-style-type: none"> <li>• Cerradura de sólo picaporte</li> <li>• Medio cilindro redondo 5962T30/3</li> <li>• Cerradero CE249R/2</li> </ul>	1962T60/2	40	62		HL	CL	1	20
	1962T70/2	50	72		HL	CL	1	20



**CARACTERÍSTICAS**

- Frente de hierro latonado
- Picaporte reversible accionable mediante manilla
- Palanca deslizante accionado por llave gorja
- Cerradero según cerradura
- Componentes de sujeción

**ACCESORIOS OPCIONALES**



DESCRIPCIÓN	REF.	MEDIDAS		LEVA	ACABADOS		UDS	
		B	A		FRENTE	CILINDRO		

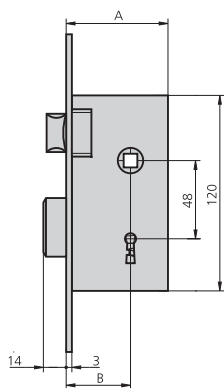

- Cerradura con picaporte y palanca
- Llave de gorja
- Cerradero CE1960/2

63R50/2	30	52	HL	1	20
63R60/2	40	62	HL	1	20
63R70/2	50	72	HL	1	20

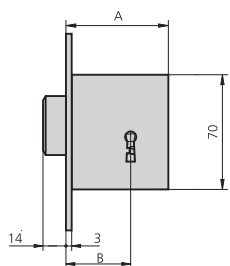

- Cerradura con sólo palanca
- Llave de gorja
- Cerradero CE1960A/2

62/50/2	30	52	HL	1	30
62/60/2	40	62	HL	1	30

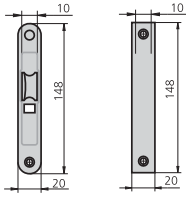
**CARACTERÍSTICAS**

- Picaporte unificado
- Frente de hierro latonado o níquel satinado
- Picaporte reversible accionable mediante manilla
- Condena a 47 mm y a 70 mm
- Cerradero CE942R30/2 o CE942R30/7
- Componentes de sujeción

**ACCESORIOS OPCIONALES**

DESCRIPCIÓN	REF.	MEDIDAS		LEVA	ACABADOS		CANTO	UDS	
		B	A		FRENTE	CILINDRO			
<ul style="list-style-type: none"> <li>• Picaporte con condena</li> <li>• Condena accionable mediante muletilla</li> <li>• Canto redondo o canto cuadrado</li> </ul>	943/2R	50	70		HL	Red	1	30	
	943/2C	50	70		HL	Cua	1	30	
	943/7R	50	70		NS	Red	1	30	
	943/7C	50	70		NS	Cua	1	30	
<ul style="list-style-type: none"> <li>• Picaporte de paso</li> <li>• Canto redondo o canto cuadrado</li> </ul>	943P/2R	50	70		HL	Red	1	30	
	943P/2C	50	70		HL	Cua	1	30	
	943P/7R	50	70		NS	Red	1	30	
	943P/7C	50	70		NS	Cua	1	30	



CARACTERÍSTICAS

- Frente de hierro latonado
- Picaporte reversible accionable mediante manilla
- Condena a 47 mm
- Cerradero CE942R30/2
- Componentes de sujeción

ACCESORIOS OPCIONALES

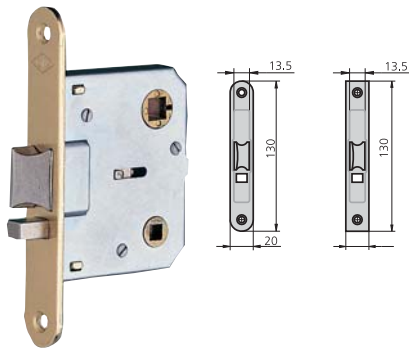

DESCRIPCIÓN

REF.

MEDIDAS

B A

ACABADOS  
FRENTE CILINDRO

CANTO



UDS

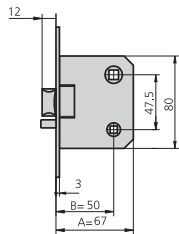

- Picaporte con condena
- Condena accionable mediante muletilla
- Canto redondo ó canto cuadrado

942RC/R/2  
942RC/C/2

50 67  
50 67

HL  
HL

Red  
Cua

1  
1

30  
30

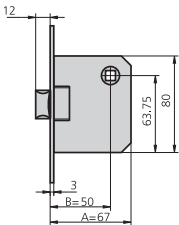

- Picaporte de paso
- Canto redondo o canto cuadrado

942R/R/2  
942R/C/2

50 67  
50 67

HL  
HL

Red  
Cua

1  
1

30  
30

**CARACTERÍSTICAS**

- Frente de hierro latonado
- Picaporte reversible accionable mediante manilla
- Cerradero según cerradura
- Componentes de sujeción

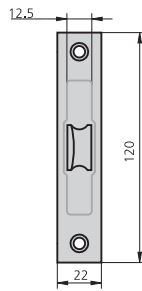
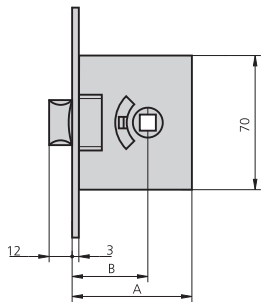
**ACCESORIOS OPCIONALES**

**DESCRIPCIÓN**
**REF.**
**MEDIDAS**  
**B A**
**ACABADOS**  
**FRENTE CILINDRO**
**CANTO**
**UDS**

- Cerradura reversible
- Picaporte accionable mediante manilla
- Cerradero CE249R/2

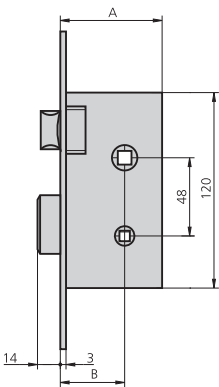
249B50/2	37	52	HL		1	20
249B60/2	44	62	HL		1	20



- Cerradura con picaporte y palanca
- Con condena
- Cerradero CE1960/2

249C50/2	30	52	HL		1	20
249C60/2	40	62	HL		1	20
249C70/2	50	72	HL		1	20

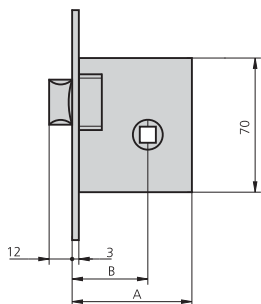

- Picaporte reversible accionable mediante manilla
- Cerradero CE249R/2

249R50/2	30	52	HL		1	30
249R60/2	40	62	HL		1	30
249R70/2	50	72	HL		1	30

DESCRIPCIÓN

REF.

ACABADO

APLICABLE A  
CERRADURAS

UDS

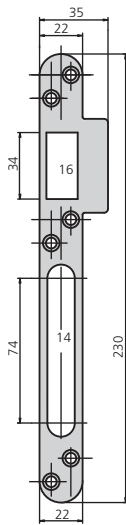

CE4000/2 HL 4000, 4010  
CE4000/6 AI

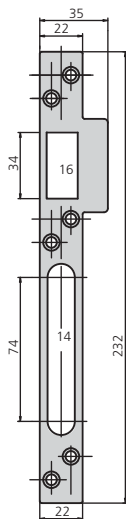

CE4001/2 HL 4001, 4011  
CE4001/6 AI

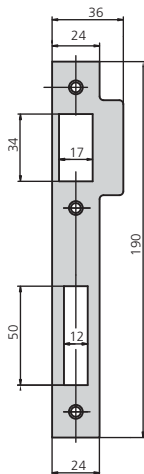



CE1985/2 HL 1970, 1970C, 1970V  
CE1985/6 AI 1985, 1985C, 1985/3P

DESCRIPCIÓN	REF.	ACABADO	APLICABLE A CERRADURAS	UDS	
	CE1970R/2	HL	1970T, 1985T		
	CE1970R/6	AI			
	CE1960/2	HL	1960, 1961, 1962,		
	CE1960/6	AI	249C, 63R		
	CE1960A/2	HL	1960A, 1961A, 1962A,		
	CE1960A/6	AI			
	CE249R/2	HL	1960T, 1962T, 249B,		
	CE249R/6	AI	249R		
	CE942R25/2	HL	943/R, 943P/R, 942C/R,		
	CE942R30/2	HL	942R/R, 942RC/R		
	CE942R30/7	NS			
	CE942R35/2	HL			
	CE942R35/7	NS			







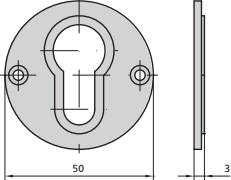

## ACCESORIOS

## CERRADEROS

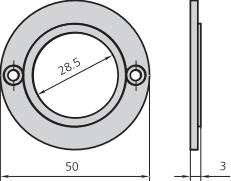
DESCRIPCIÓN	REF.	ACABADO	APLICABLE A CERRADURAS	UDS
	CE942C30/2	HL	942/C, 943P/C, 942C/C,	 
	CE942C35/2	HL	942R/C, 942RC/C	

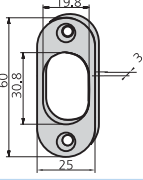

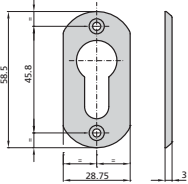

## ACCESORIOS

## ESCUDOS

DESCRIPCIÓN	REF.	ACABADO	APLICABLE A CERRADURAS	UDS
	ES1960	LP	1960, 1970,	 
	ES1960/4	LN	1985, 156	
	ES1962	LP	1962, 11981	 
	ES1962/4	LN		
	ES1964	Escudo de nylon	1961	 
	ES1985/0	Nickel plated	1985, 1970, 1960	 
	ES1985/1D	Gold painted		
	ES1985/2	Brass		
	ES1985/7	Matt nickel		

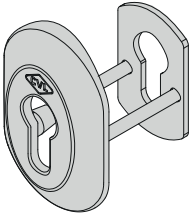
## ACCESORIOS

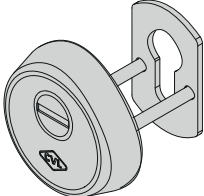
## ESCUDOS DE SEGURIDAD

DESCRIPCIÓN	REF.	ACABADO	APLICABLE A CERRADURAS	UDS
	KES4000		4000, 4001, 4010, 4011, 4100, 4110	 
	KES4100		4000, 4001, 4010, 4011, 4100, 4110	 

## CILINDROS

	<b>Cilindro europerfil normal leva larga</b>	<b>122</b>
	• Serie 5982	122
	• Serie 5982P	124
	• Serie 5982T	124
	• Serie 5982PT	124
	<b>Cilindro europerfil normal leva corta</b>	<b>126</b>
	• Serie 5990	126
	• Serie 5990P	128
	• Serie 5990T	128
	• Serie 5990PT	128
	<b>Cilindro europerfil de seguridad leva larga</b>	<b>130</b>
	• Serie 6982	130
	• Serie 6982P	132
	• Serie 6982T	132
	<b>Cilindro europerfil de seguridad leva corta</b>	<b>133</b>
	• Serie 6990	133
	• Serie 6990P	135
	• Serie 6990T	135
	<b>Cilindros ovalados y redondos</b>	<b>136</b>
	• Serie 5963	136
• Serie 5081	137	
• Serie 5961	138	
• Serie 5962	139	
• Serie 5964	140	
• Serie 5968	141	
• Serie 5979	142	

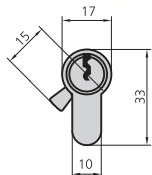





CARACTERÍSTICAS

- Cuerpo de latón
- Rotores de latón
- Leva larga de 15 mm
- 5 pitones
- 3 llaves

ACCESORIOS OPCIONALES

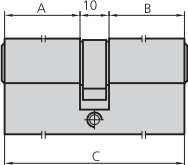

DESCRIPCIÓN	REF.	MEDIDAS			ACABADOS	UDS	
		A	B	C			
 <ul style="list-style-type: none"> <li>• Cilindro doble</li> </ul>	5982/2525/3	26	26	62	LP	1	
	5982/2525/4	26	26	62	LN	1	
	5982/2530/3	26	31	67	LP	1	
	5982/2530/4	26	31	67	LN	1	
	5982/2535/3	26	36	72	LP	1	
	5982/2535/4	26	36	72	LN	1	
	5982/3030/3	31	31	72	LP	1	
	5982/3030/4	31	31	72	LN	1	
	5982/2540/3	26	41	77	LP	1	
	5982/2540/4	26	41	77	LN	1	
	5982/3035/3	31	36	77	LP	1	
	5982/3035/4	31	36	77	LN	1	
	5982/2545/3	26	46	82	LP	1	
	5982/2545/4	26	46	82	LN	1	
	5982/3040/3	31	41	82	LP	1	
	5982/3040/4	31	41	82	LN	1	
	5982/3535/3	36	36	82	LP	1	
	5982/3535/4	36	36	82	LN	1	
	5982/2550/3	26	51	87	LP	1	
	5982/2550/4	26	51	87	LN	1	
5982/3540/3	36	41	87	LP	1		
5982/3540/4	36	41	87	LN	1		
5982/3045/3	31	46	87	LP	1		
5982/3045/4	31	46	87	LN	1		
5982/2555/3	26	56	92	LP	1		
5982/2555/4	26	56	92	LN	1		
5982/3050/3	31	51	92	LP	1		
5982/3050/4	31	51	92	LN	1		
5982/3545/3	36	46	92	LP	1		
5982/3545/4	36	46	92	LN	1		
5982/4040/3	41	41	92	LP	1		
5982/4040/4	41	41	92	LN	1		
5982/2560/3	26	61	97	LP	1		
5982/2560/4	26	61	97	LN	1		
5982/3055/3	31	56	97	LP	1		
5982/3055/4	31	56	97	LN	1		
5982/2565/3	26	66	102	LP	1		
5982/2565/4	26	66	102	LN	1		
5982/3060/3	31	61	102	LP	1		
5982/3060/4	31	61	102	LN	1		
5982/3555/3	36	56	102	LP	1		
5982/3555/4	36	56	102	LN	1		

DESCRIPCIÓN	REF.	MEDIDAS			ACABADOS	UDS  
		A	B	C		
5982/4050/3	41	51	102	LP	1	
5982/4050/4	41	51	102	LN	1	
5982/4545/3	46	46	102	LP	1	
5982/4545/4	46	46	102	LN	1	
5982/4055/3	41	56	107	LP	1	
5982/4055/4	41	56	107	LN	1	
5982/2575/3	26	76	112	LP	1	
5982/2575/4	26	76	112	LN	1	
5982/3565/3	36	66	112	LP	1	
5982/3565/4	36	66	112	LN	1	
5982/4060/3	41	61	112	LP	1	
5982/4060/4	41	61	112	LN	1	
5982/4555/3	46	56	112	LP	1	
5982/4555/4	46	56	112	LN	1	
5982/5050/3	51	51	112	LP	1	
5982/5050/4	51	51	112	LN	1	
5982/2585/3	26	86	122	LP	1	
5982/2585/4	26	86	122	LN	1	
5982/3080/3	31	81	122	LP	1	
5982/3080/4	31	81	122	LN	1	
5982/3575/3	36	76	122	LP	1	
5982/3575/4	36	76	122	LN	1	
5982/4070/3	41	71	122	LP	1	
5982/4070/4	41	71	122	LN	1	
5982/5555/3	56	56	122	LP	1	
5982/5555/4	56	56	122	LN	1	
5982/2595/3	26	96	132	LP	1	
5982/2595/4	26	96	132	LN	1	
5982/4080/3	41	81	132	LP	1	
5982/4080/4	41	81	132	LN	1	
5982/6060/3	61	61	132	LP	1	
5982/6060/4	61	61	132	LN	1	
5982/3595/3	36	96	142	LP	1	
5982/3595/4	36	96	142	LN	1	
5982/6565/3	66	66	142	LP	1	
5982/6565/4	66	66	142	LN	1	
5982/7070/3	71	71	152	LP	1	
5982/7070/4	71	71	152	LN	1	
5982/7575/3	76	76	162	LP	1	
5982/7575/4	76	76	162	LN	1	



DESCRIPCIÓN

REF.

MEDIDAS

ACABADOS

UDS

A

B

C



- Cilindro con pomo

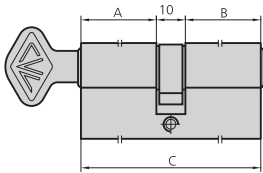

5982P2525/3	26	26	62	LP	1
5982P2525/4	26	26	62	LN	1
5982P2530/3	26	31	67	LP	1
5982P2530/4	26	31	67	LN	1
5982P2535/3	26	36	72	LP	1
5982P2535/4	26	36	72	LN	1
5982P3030/3	31	31	72	LP	1
5982P3030/4	31	31	72	LN	1
5982P3525/3	36	26	72	LP	1
5982P3525/4	36	26	72	LN	1
5982P2540/3	26	41	77	LP	1
5982P2540/4	26	41	77	LN	1
5982P2545/3	26	46	82	LP	1
5982P2545/4	26	46	82	LN	1
5982P3535/3	36	36	82	LP	1
5982P3535/4	36	36	82	LN	1
5982P2550/3	26	51	87	LP	1
5982P2550/4	26	51	87	LN	1
5982P3045/3	31	46	87	LP	1
5982P3045/4	31	46	87	LN	1
5982P3540/3	36	41	87	LP	1
5982P3540/4	36	41	87	LN	1
5982P2555/3	26	56	92	LP	1
5982P2555/4	26	56	92	LN	1
5982P3545/3	36	46	92	LP	1
5982P3545/4	36	46	92	LN	1
5982P2560/3	26	61	97	LP	1
5982P2560/4	26	61	97	LN	1
5982P2565/3	26	66	102	LP	1
5982P2565/4	26	66	102	LN	1

- Medio cilindro

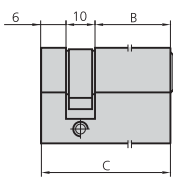

5982T40/3		26	42	LP	1
5982T40/4		26	42	LN	1
5982T45/3		31	47	LP	1
5982T45/4		31	47	LN	1
5982T50/3		36	52	LP	1
5982T50/4		36	52	LN	1
5982T55/3		41	57	LP	1
5982T55/4		41	57	LN	1
5982T60/3		46	62	LP	1
5982T60/4		46	62	LN	1
5982T65/3		51	67	LP	1
5982T65/4		51	67	LN	1
5982T70/3		56	72	LP	1
5982T70/4		56	72	LN	1

- Medio cilindro
- Triángulo por un lado

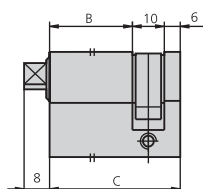

5982PT2505/3		26	42	LP	1
5982PT2505/4		26	42	LN	1

DESCRIPCIÓN	REF.	MEDIDAS			ACABADOS	UDS	
		A	B	C			
<ul style="list-style-type: none"> <li>• Doble cilindro</li> <li>• Llave por un lado y triángulo por el otro</li> </ul>	5982PT2525/3	26	26	62	LP	1	
	5982PT2525/4	26	26	62	LN	1	
	5982PT2535/3	26	36	72	LP	1	
	5982PT2535/4	26	36	72	LN	1	
	5982PT2545/3	26	46	82	LP	1	
	5982PT2545/4	26	46	82	LN	1	



<ul style="list-style-type: none"> <li>• Doble cilindro</li> <li>• Triángulo por un lado y pomo por el otro</li> </ul>	5982P25T25/3	26	26	62	LP	1	
	5982P25T25/4	26	26	62	LN	1	
	5982P30T30/3	31	31	72	LP	1	
	5982P30T30/4	31	31	72	LN	1	
	5982P35T25/3	36	26	72	LP	1	
	5982P35T25/4	36	26	72	LN	1	
	5982P35T35/3	36	36	82	LP	1	
	5982P35T35/4	36	36	82	LN	1	
	5982P30T45/3	31	46	87	LP	1	
	5982P30T45/4	31	46	87	LN	1	

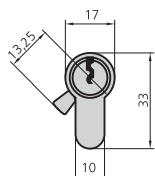

CARACTERÍSTICAS

- Cuerpo de latón
- Rotores de latón
- Leva corta de 13,25 mm
- 5 pitones
- 3 llaves

ACCESORIOS OPCIONALES

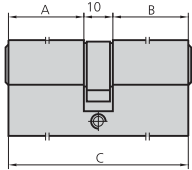

DESCRIPCIÓN	REF.	MEDIDAS			ACABADOS	UDS	
		A	B	C			
 <ul style="list-style-type: none"> <li>• Cilindro doble</li> </ul>	5990/2525/3	26	26	62	LP	1	
	5990/2525/4	26	26	62	LN	1	
	5990/2530/3	26	31	67	LP	1	
	5990/2530/4	26	31	67	LN	1	
	5990/2535/3	26	36	72	LP	1	
	5990/2535/4	26	36	72	LN	1	
	5990/3030/3	31	31	72	LP	1	
	5990/3030/4	31	31	72	LN	1	
	5990/2540/3	26	41	77	LP	1	
	5990/2540/4	26	41	77	LN	1	
	5990/3035/3	31	36	77	LP	1	
	5990/3035/4	31	36	77	LN	1	
	5990/2545/3	26	46	82	LP	1	
	5990/2545/4	26	46	82	LN	1	
	5990/3040/3	31	41	82	LP	1	
	5990/3040/4	31	41	82	LN	1	
	5990/3535/3	36	36	82	LP	1	
	5990/3535/4	36	36	82	LN	1	
	5990/2550/3	26	51	87	LP	1	
	5990/2550/4	26	51	87	LN	1	
	5990/3540/3	36	41	87	LP	1	
	5990/3540/4	36	41	87	LN	1	
	5990/3045/3	31	46	87	LP	1	
	5990/3045/4	31	46	87	LN	1	
	5990/2555/3	26	56	92	LP	1	
	5990/2555/4	26	56	92	LN	1	
	5990/3050/3	31	51	92	LP	1	
	5990/3050/4	31	51	92	LN	1	
	5990/3545/3	36	46	92	LP	1	
	5990/3545/4	36	46	92	LN	1	
5990/4040/3	41	41	92	LP	1		
5990/4040/4	41	41	92	LN	1		
5990/2560/3	26	61	97	LP	1		
5990/2560/4	26	61	97	LN	1		
5990/3055/3	31	56	97	LP	1		
5990/3055/4	31	56	97	LN	1		
5990/2565/3	26	66	102	LP	1		
5990/2565/4	26	66	102	LN	1		

DESCRIPCIÓN	REF.	MEDIDAS			ACABADOS	UDS  
		A	B	C		
	5990/3060/3	31	61	102	LP	1
	5990/3060/4	31	61	102	LN	1
	5990/3555/3	36	56	102	LP	1
	5990/3555/4	36	56	102	LN	1
	5990/4050/3	41	51	102	LP	1
	5990/4050/4	41	51	102	LN	1
	5990/4545/3	46	46	102	LP	1
	5990/4545/4	46	46	102	LN	1
	5990/4055/3	41	56	107	LP	1
	5990/4055/4	41	56	107	LN	1
	5990/2575/3	26	76	112	LP	1
	5990/2575/4	26	76	112	LN	1
	5990/3565/3	36	66	112	LP	1
	5990/3565/4	36	66	112	LN	1
	5990/4060/3	41	61	112	LP	1
	5990/4060/4	41	61	112	LN	1
	5990/4555/3	46	56	112	LP	1
	5990/4555/4	46	56	112	LN	1
	5990/5050/3	51	51	112	LP	1
	5990/5050/4	51	51	112	LN	1
	5990/2585/3	26	86	122	LP	1
	5990/2585/4	26	86	122	LN	1
	5990/3080/3	31	81	122	LP	1
	5990/3080/4	31	81	122	LN	1
	5990/3575/3	36	76	122	LP	1
	5990/3575/4	36	76	122	LN	1
	5990/4070/3	41	71	122	LP	1
	5990/4070/4	41	71	122	LN	1
	5990/5555/3	56	56	122	LP	1
	5990/5555/4	56	56	122	LN	1
	5990/2595/3	26	96	132	LP	1
	5990/2595/4	26	96	132	LN	1
	5990/4080/3	41	81	132	LP	1
	5990/4080/4	41	81	132	LN	1
	5990/6060/3	61	61	132	LP	1
	5990/6060/4	61	61	132	LN	1
	5990/3595/3	36	96	142	LP	1
	5990/3595/4	36	96	142	LN	1
	5990/6565/3	66	66	142	LP	1
	5990/6565/4	66	66	142	LN	1
	5990/7070/3	71	71	152	LP	1
	5990/7070/4	71	71	152	LN	1
	5990/7575/3	76	76	162	LP	1
	5990/7575/4	76	76	162	LN	1

DESCRIPCIÓN

REF.

MEDIDAS

ACABADOS

UDS

A

B

C

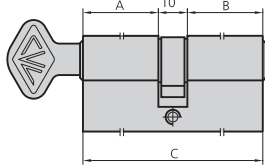

- Cilindro con pomo

5990P2525/3	26	26	62	LP	1
5990P2525/4	26	26	62	LN	1
5990P2530/3	26	31	67	LP	1
5990P2530/4	26	31	67	LN	1
5990P2535/3	26	36	72	LP	1
5990P2535/4	26	36	72	LN	1
5990P3030/3	31	31	72	LP	1
5990P3030/4	31	31	72	LN	1
5990P3525/3	36	26	72	LP	1
5990P3525/4	36	26	72	LN	1
5990P2540/3	26	41	77	LP	1
5990P2540/4	26	41	77	LN	1
5990P2545/3	26	46	82	LP	1
5990P2545/4	26	46	82	LN	1
5990P3535/3	36	36	82	LP	1
5990P3535/4	36	36	82	LN	1
5990P2550/3	26	51	87	LP	1
5990P2550/4	26	51	87	LN	1
5990P3045/3	31	46	87	LP	1
5990P3045/4	31	46	87	LN	1
5990P3540/3	36	41	87	LP	1
5990P3540/4	36	41	87	LN	1
5990P2555/3	26	56	92	LP	1
5990P2555/4	26	56	92	LN	1
5990P3545/3	36	46	92	LP	1
5990P3545/4	36	46	92	LN	1
5990P2560/3	26	61	97	LP	1
5990P2560/4	26	61	97	LN	1
5990P2565/3	26	66	102	LP	1
5990P2565/4	26	66	102	LN	1

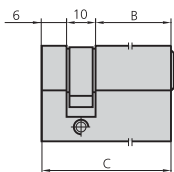

- Medio cilindro

5990T40/3		26	42	LP	1
5990T40/4		26	42	LN	1
5990T45/3		31	47	LP	1
5990T45/4		31	47	LN	1
5990T50/3		36	52	LP	1
5990T50/4		36	52	LN	1
5990T55/3		41	57	LP	1
5990T55/4		41	57	LN	1
5990T60/3		46	62	LP	1
5990T60/4		46	62	LN	1
5990T65/3		51	67	LP	1
5990T65/4		51	67	LN	1
5990T70/3		56	72	LP	1
5990T70/4		56	72	LN	1

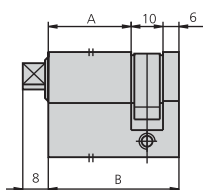

- Medio cilindro
- Triángulo por un lado

5990PT2505/3		26	42	LP	1
5990PT2505/4		26	42	LN	1

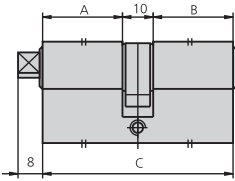
DESCRIPCIÓN	REF.	MEDIDAS			ACABADOS	UDS
		A	B	C		
 <ul style="list-style-type: none"> <li>• Doble cilindro</li> <li>• Llave por un lado y triángulo por el otro</li> </ul>	5990PT2525/3	26	26	62	LP	1
	5990PT2525/4	26	26	62	LN	1
	5990PT2535/3	26	36	72	LP	1
	5990PT2535/4	26	36	72	LN	1
	5990PT2545/3	26	46	82	LP	1
	5990PT2545/4	26	46	82	LN	1

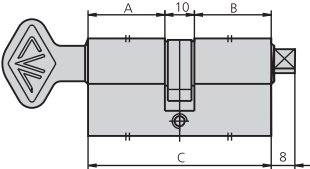
 <ul style="list-style-type: none"> <li>• Doble cilindro</li> <li>• Triángulo por un lado y pomo por el otro</li> </ul>	5990P25T25/3	26	26	62	LP	1
	5990P25T25/4	26	26	62	LN	1
	5990P30T30/3	31	31	72	LP	1
	5990P30T30/4	31	31	72	LN	1
	5990P35T25/3	36	26	72	LP	1
	5990P35T25/4	36	26	72	LN	1
	5990P35T35/3	36	36	82	LP	1
	5990P35T35/4	36	36	82	LN	1
	5990P30T45/3	31	46	87	LP	1
	5990P30T45/4	31	46	87	LN	1

CARACTERÍSTICAS



ACCESORIOS OPCIONALES



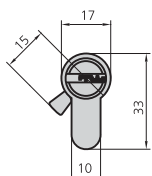

- Cuerpo de latón
- Rotores de latón
- Leva larga de 15 mm
- Pasadores antitaladro
- 5 pitones de inoxidable
- 5 llaves



DESCRIPCIÓN	REF.	MEDIDAS			ACABADOS	UDS	
		A	B	C			
<ul style="list-style-type: none"> <li>• Cilindro doble</li> </ul>	6982/2525/3	26	26	62	LP	1	
	6982/2525/4	26	26	62	LN	1	
	6982/2530/3	26	31	67	LP	1	
	6982/2530/4	26	31	67	LN	1	
	6982/2535/3	26	36	72	LP	1	
	6982/2535/4	26	36	72	LN	1	
	6982/3030/3	31	31	72	LP	1	
	6982/3030/4	31	31	72	LN	1	
	6982/2540/3	26	41	77	LP	1	
	6982/2540/4	26	41	77	LN	1	
	6982/3035/3	31	36	77	LP	1	
	6982/3035/4	31	36	77	LN	1	
	6982/2545/3	26	46	82	LP	1	
	6982/2545/4	26	46	82	LN	1	
	6982/3040/3	31	41	82	LP	1	
	6982/3040/4	31	41	82	LN	1	
	6982/3535/3	36	36	82	LP	1	
	6982/3535/4	36	36	82	LN	1	
	6982/2550/3	26	51	87	LP	1	
	6982/2550/4	26	51	87	LN	1	
	6982/3540/3	36	41	87	LP	1	
	6982/3540/4	36	41	87	LN	1	
	6982/3045/3	31	46	87	LP	1	
	6982/3045/4	31	46	87	LN	1	
	6982/2555/3	26	56	92	LP	1	
	6982/2555/4	26	56	92	LN	1	
	6982/3050/3	31	51	92	LP	1	
	6982/3050/4	31	51	92	LN	1	
	6982/3545/3	36	46	92	LP	1	
	6982/3545/4	36	46	92	LN	1	
	6982/4040/3	41	41	92	LP	1	
	6982/4040/4	41	41	92	LN	1	
	6982/2560/3	26	61	97	LP	1	
	6982/2560/4	26	61	97	LN	1	
	6982/3055/3	31	56	97	LP	1	
	6982/3055/4	31	56	97	LN	1	
	6982/4045/3	41	46	97	LP	1	
	6982/4045/4	41	46	97	LN	1	

DESCRIPCIÓN	REF.	MEDIDAS			ACABADOS	UDS  
		A	B	C		
	6982/2565/3	26	66	102	LP	1
	6982/2565/4	26	66	102	LN	1
	6982/3060/3	31	61	102	LP	1
	6982/3060/4	31	61	102	LN	1
	6982/3555/3	36	56	102	LP	1
	6982/3555/4	36	56	102	LN	1
	6982/4050/3	41	51	102	LP	1
	6982/4050/4	41	51	102	LN	1
	6982/4545/3	46	46	102	LP	1
	6982/4545/4	46	46	102	LN	1
	6982/4055/3	41	56	107	LP	1
	6982/4055/4	41	56	107	LN	1
	6982/2575/3	26	76	112	LP	1
	6982/2575/4	26	76	112	LN	1
	6982/3565/3	36	66	112	LP	1
	6982/3565/4	36	66	112	LN	1
	6982/4555/3	46	56	112	LP	1
	6982/4555/4	46	56	112	LN	1
	6982/5050/3	51	51	112	LP	1
	6982/5050/4	51	51	112	LN	1
	6982/4560/3	46	61	117	LP	1
	6982/4560/4	46	61	117	LN	1
	6982/2585/3	26	86	122	LP	1
	6982/2585/4	26	86	122	LN	1
	6982/5555/3	56	56	122	LP	1
	6982/5555/4	56	56	122	LN	1
	6982/2595/3	26	96	132	LP	1
	6982/2595/4	26	96	132	LN	1
	6982/6565/3	66	66	142	LP	1
	6982/6565/4	66	66	142	LN	1
	6982/7070/3	71	71	152	LP	1
	6982/7070/4	71	71	152	LN	1
	6982/7575/3	76	76	162	LP	1
	6982/7575/4	76	76	162	LN	1

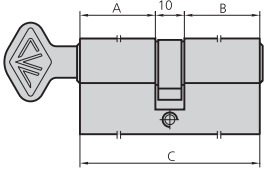

DESCRIPCIÓN	REF.	MEDIDAS			ACABADOS	UDS  
		A	B	C		
 <ul style="list-style-type: none"> <li>• Cilindro con pomo</li> </ul>	6982P2525/3	26	26	62	LP	1
	6982P2525/4	26	26	62	LN	1
	6982P2535/3	26	36	72	LP	1
	6982P2535/4	26	36	72	LN	1
	6982P3525/3	36	26	72	LP	1
	6982P3525/4	36	26	72	LN	1
	6982P3030/3	31	31	72	LP	1
	6982P3030/4	31	31	72	LN	1
	6982P2545/3	26	46	82	LP	1
	6982P2545/4	26	46	82	LN	1
	6982P3535/3	36	36	82	LP	1
	6982P3535/4	36	36	82	LN	1
	6982P2555/3	26	56	92	LP	1
	6982P2555/4	26	56	92	LN	1
	6982P3545/3	36	46	92	LP	1
	6982P3545/4	36	46	92	LN	1
	6982P3555/3	36	56	102	LP	1
	6982P3555/4	36	56	102	LN	1
	6982P3565/3	36	66	112	LP	1
	6982P3565/4	36	66	112	LN	1

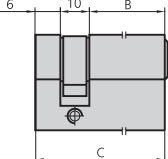

 <ul style="list-style-type: none"> <li>• Medio cilindro</li> </ul>	6982T40/3		26	42	LP	1
	6982T40/4		26	42	LN	1
	6982T50/3		36	52	LP	1
	6982T50/4		36	52	LN	1
	6982T60/3		46	62	LP	1
	6982T60/4		46	62	LN	1
	6982T70/3		56	72	LP	1
	6982T70/4		56	72	LN	1



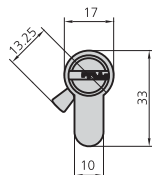

**CARACTERÍSTICAS**

- Cuerpo de latón
- Rotores de latón
- Leva corta de 13,25 mm
- Pasadores antitaladro
- 5 pitones de inoxidable
- 5 llaves

**ACCESORIOS OPCIONALES**

DESCRIPCIÓN	REF.	MEDIDAS			ACABADOS	UDS	
		A	B	C			
<ul style="list-style-type: none"> <li>• Cilindro doble</li> </ul>	6990/2525/3	26	26	62	LP	1	
	6990/2525/4	26	26	62	LN	1	
	6990/2530/3	26	31	67	LP	1	
	6990/2530/4	26	31	67	LN	1	
	6990/2535/3	26	36	72	LP	1	
	6990/2535/4	26	36	72	LN	1	
	6990/3030/3	31	31	72	LP	1	
	6990/3030/4	31	31	72	LN	1	
	6990/2540/3	26	41	77	LP	1	
	6990/2540/4	26	41	77	LN	1	
	6990/3035/3	31	36	77	LP	1	
	6990/3035/4	31	36	77	LN	1	
	6990/2545/3	26	46	82	LP	1	
	6990/2545/4	26	46	82	LN	1	
	6990/3040/3	31	41	82	LP	1	
	6990/3040/4	31	41	82	LN	1	
	6990/3535/3	36	36	82	LP	1	
	6990/3535/4	36	36	82	LN	1	
	6990/2550/3	26	51	87	LP	1	
	6990/2550/4	26	51	87	LN	1	
6990/3540/3	36	41	87	LP	1		
6990/3540/4	36	41	87	LN	1		
6990/3045/3	31	46	87	LP	1		
6990/3045/4	31	46	87	LN	1		
6990/2555/3	26	56	92	LP	1		
6990/2555/4	26	56	92	LN	1		
6990/3050/3	31	51	92	LP	1		
6990/3050/4	31	51	92	LN	1		
6990/3545/3	36	46	92	LP	1		
6990/3545/4	36	46	92	LN	1		
6990/4040/3	41	41	92	LP	1		
6990/4040/4	41	41	92	LN	1		
6990/2560/3	26	61	97	LP	1		
6990/2560/4	26	61	97	LN	1		
6990/3055/3	31	56	97	LP	1		
6990/3055/4	31	56	97	LN	1		
6990/4045/3	41	46	97	LP	1		
6990/4045/4	41	46	97	LN	1		

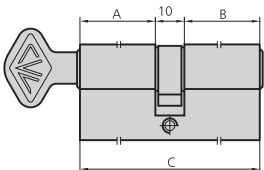
DESCRIPCIÓN	REF.	MEDIDAS			ACABADOS	UDS	
		A	B	C			
	6990/2565/3	26	66	102	LP	1	
	6990/2565/4	26	66	102	LN	1	
	6990/3060/3	31	61	102	LP	1	
	6990/3060/4	31	61	102	LN	1	
	6990/3555/3	36	56	102	LP	1	
	6990/3555/4	36	56	102	LN	1	
	6990/4050/3	41	51	102	LP	1	
	6990/4050/4	41	51	102	LN	1	
	6990/4545/3	46	46	102	LP	1	
	6990/4545/4	46	46	102	LN	1	
	6990/4055/3	41	56	107	LP	1	
	6990/4055/4	41	56	107	LN	1	
	6990/2575/3	26	76	112	LP	1	
	6990/2575/4	26	76	112	LN	1	
	6990/3565/3	36	66	112	LP	1	
	6990/3565/4	36	66	112	LN	1	
	6990/4555/3	46	56	112	LP	1	
	6990/4555/4	46	56	112	LN	1	
	6990/5050/3	51	51	112	LP	1	
	6990/5050/4	51	51	112	LN	1	
	6990/4560/3	46	61	117	LP	1	
	6990/4560/4	46	61	117	LN	1	
	6990/2585/3	26	86	122	LP	1	
	6990/2585/4	26	86	122	LN	1	
	6990/5555/3	56	56	122	LP	1	
	6990/5555/4	56	56	122	LN	1	
	6990/2595/3	26	96	132	LP	1	
	6990/2595/4	26	96	132	LN	1	
	6990/6565/3	66	66	142	LP	1	
	6990/6565/4	66	66	142	LN	1	
	6990/7070/3	71	71	152	LP	1	
	6990/7070/4	71	71	152	LN	1	
	6990/7575/3	76	76	162	LP	1	
	6990/7575/4	76	76	162	LN	1	

DESCRIPCIÓN	REF.	MEDIDAS			ACABADOS	UDS  
		A	B	C		
 <ul style="list-style-type: none"> <li>• Cilindro con pomo</li> </ul>	6990P2525/3	26	26	62	LP	1
	6990P2525/4	26	26	62	LN	1
	6990P2535/3	26	36	72	LP	1
	6990P2535/4	26	36	72	LN	1
	6990P3525/3	36	26	72	LP	1
	6990P3525/4	36	26	72	LN	1
	6990P3030/3	31	31	72	LP	1
	6990P3030/4	31	31	72	LN	1
	6990P2545/3	26	46	82	LP	1
	6990P2545/4	26	46	82	LN	1
	6990P3535/3	36	36	82	LP	1
	6990P3535/4	36	36	82	LN	1
	6990P2555/3	26	56	92	LP	1
	6990P2555/4	26	56	92	LN	1
	6990P3545/3	36	46	92	LP	1
	6990P3545/4	36	46	92	LN	1
	6990P3555/3	36	56	102	LP	1
	6990P3555/4	36	56	102	LN	1
	6990P3565/3	36	66	112	LP	1
	6990P3565/4	36	66	112	LN	1

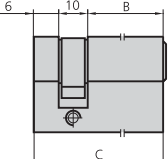

 <ul style="list-style-type: none"> <li>• Medio cilindro</li> </ul>	6990T40/3		26	42	LP	1
	6990T40/4		26	42	LN	1
	6990T50/3		36	52	LP	1
	6990T50/4		36	52	LN	1
	6990T60/3		46	62	LP	1
	6990T60/4		46	62	LN	1
	6990T70/3		56	72	LP	1
	6990T70/4		56	72	LN	1

CARACTERÍSTICAS

- Cilindro ovalado pequeño
- Cuerpo de latón
- Rotores de latón
- Dos levas
- 3 llaves

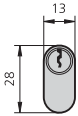
ACCESORIOS OPCIONALES

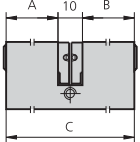
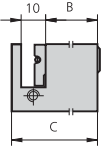

DESCRIPCIÓN	REF.	MEDIDAS			ACABADOS	APLICABLE A CERRADURAS	UDS	
		A	B	C				
 <ul style="list-style-type: none"> <li>• Cilindro doble</li> </ul>	5963/2222/3	22	22	54	LP	1963 1975	1	
	5963/2222/4	22	22	54	LN		1	
	5963/2525/3	26	26	62	LP		1	
	5963/2525/4	26	26	62	LN		1	
	5963/3030/3	31	31	72	LP		1	
	5963/3030/4	31	31	72	LN		1	
	5963/3535/3	36	36	82	LP		1	
	5963/3535/4	36	36	82	LN		1	
	5963/4040/3	41	41	92	LP		1	
	5963/4040/4	41	41	92	LN		1	
 <ul style="list-style-type: none"> <li>• Medio cilindro</li> </ul>	5963T36/3		22	36	LP	1963	1	
	5963T36/4		22	36	LN	1975	1	

**CARACTERÍSTICAS**

- Cuerpo de latón
- Rotores de latón
- Con levas y vástagos
- 3 llaves

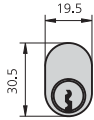
**ACCESORIOS OPCIONALES**

DESCRIPCIÓN	REF.	MEDIDAS			ACABADOS	APLICABLE A CERRADURAS	UDS	
		A	B	C				
<ul style="list-style-type: none"> <li>• Cilindro doble</li> <li>• Ovalado</li> </ul>	5081/3030/3	26,5	26,5	74	LP	1981	1	
	5081/3030/4	26,5	26,5	74	LN		1	
<ul style="list-style-type: none"> <li>• Cilindro doble</li> <li>• Redondo</li> </ul>	5181/3030/3	26,5	26,5	74	LP	11981	1	
	5181/3030/4	26,5	26,5	74	LN		1	



CARACTERÍSTICAS

- Cuerpo de latón
- Rotores de latón
- Con levas y vástagos
- 3 llaves

ACCESORIOS OPCIONALES

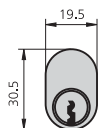

DESCRIPCIÓN	REF.	MEDIDAS			ACABADOS	APLICABLE A CERRADURAS	UDS	
		A	B	C				
<ul style="list-style-type: none"> <li>• Cilindro doble</li> <li>• Ovalado</li> </ul>	5961/2525/3	25	25	64	LP	1961		1
	5961/2525/4	25	25	64	LN			1
	5961/3030/3	30	30	74	LP			1
	5961/3030/4	30	30	74	LN			1

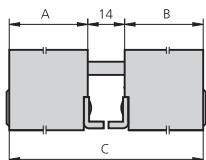

**CARACTERÍSTICAS**

- Cuerpo de latón
- Rotores de latón
- Con levas y vástagos
- 3 llaves

**ACCESORIOS OPCIONALES**

DESCRIPCIÓN	REF.	MEDIDAS			ACABADOS	APLICABLE A CERRADURAS	UDS	
		A	B	C				
<ul style="list-style-type: none"> <li>• Cilindro doble</li> <li>• Redondo</li> </ul>	5962/2525/3	25	25	64	LP	1962		1
	5962/3030/3	30	30	74	LN			1
	5962/4040/3	40	40	94	LP			1
<ul style="list-style-type: none"> <li>• Medio cilindro</li> <li>• Redondo</li> </ul>	5962T30/3			30	LP	1962		1
	5962T40/3			40	LN			1



CARACTERÍSTICAS

ACCESORIOS OPCIONALES



- Cilindro ovalado
- Cuerpo de latón
- Rotores de latón
- Con levas y vástagos

- 3 llaves

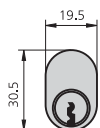

DESCRIPCIÓN	REF.	MEDIDAS			ACABADOS	APLICABLE A CERRADURAS	UDS	
		A	B	C				
<ul style="list-style-type: none"> <li>• Cilindro doble</li> <li>• Llave normal</li> </ul>	5964/2525/3	25	25	66	LP	1964	1	
	5964/2525/4	25	25	66	LN		1	
	5964/3030/3	30	30	76	LP		1	
	5964/3030/4	30	30	76	LN		1	
	5964/4040/3	40	40	96	LP		1	
	5964/4040/4	40	40	96	LN		1	
<ul style="list-style-type: none"> <li>• Cilindro doble con pomo</li> <li>• Llave normal</li> </ul>	5964P3030/3	30	30	76	LP	1964	1	
	5964P3030/4	30	30	76	LN		1	
<ul style="list-style-type: none"> <li>• Medio cilindro</li> <li>• Llave normal</li> </ul>	5964T25/3			25	LP	1964	1	
	5964T25/4			25	LN		1	
	5964T30/3			30	LP		1	
	5964T30/4			30	LN		1	
	5964T40/3			40	LP		1	
	5964T40/4			40	LN		1	
<ul style="list-style-type: none"> <li>• Cilindro doble</li> <li>• Llave de seguridad</li> </ul>	6964/3030/3	30	30	76	LP	1964	1	
	6964/3030/4	30	30	76	LN		1	
<ul style="list-style-type: none"> <li>• Medio cilindro</li> <li>• Llave de seguridad</li> </ul>	6964T30/3			30	LP	1964	1	
	6964T30/4			30	LN		1	

CILINDROS

**CARACTERÍSTICAS**

- Cilindro ovalado
  - Cuerpo de latón
  - Rotores de latón
  - Con levas y vástagos
- 
- 3 llaves

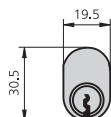
**ACCESORIOS OPCIONALES**

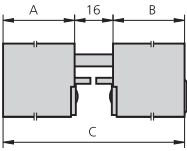
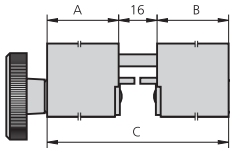
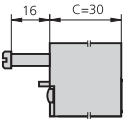
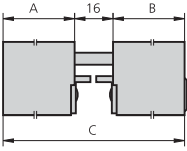
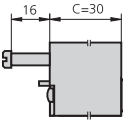
DESCRIPCIÓN	REF.	MEDIDAS			ACABADOS	APLICABLE A CERRADURAS	UDS	
		A	B	C				
 <ul style="list-style-type: none"> <li>• Cilindro doble</li> <li>• Llave normal</li> </ul>	5968/2525/3	25	25	66	LP	1968	1	
	5968/2525/4	25	25	66	LN		1	
	5968/3030/3	30	30	76	LP		1	
	5968/3030/4	30	30	76	LN		1	
	5968/4040/3	40	40	96	LP		1	
	5968/4040/4	40	40	96	LN		1	
 <ul style="list-style-type: none"> <li>• Cilindro doble con pomo</li> <li>• Llave normal</li> </ul>	5968P3030/3	30	30	76	LP	1968	1	
	5968P3030/4	30	30	76	LN		1	
 <ul style="list-style-type: none"> <li>• Medio cilindro</li> <li>• Llave normal</li> </ul>	5968T25/3			25	LP	1968	1	
	5968T25/4			25	LN		1	
	5968T30/3			30	LP		1	
	5968T30/4			30	LN		1	
	5968T40/3			40	LP		1	
5968T40/4			40	LN	1			
 <ul style="list-style-type: none"> <li>• Cilindro doble</li> <li>• Llave de seguridad</li> </ul>	6968/3030/3	30	30	76	LP	1968	1	
	6968/3030/4	30	30	76	LN		1	
 <ul style="list-style-type: none"> <li>• Medio cilindro</li> <li>• Llave de seguridad</li> </ul>	6968T30/3			30	LP	1968	1	
	6968T30/4			30	LN		1	

CARACTERÍSTICAS

ACCESORIOS OPCIONALES



- Cilindro ovalado
- Cuerpo de latón
- Rotores de latón
- Con levas y vástagos

- 3 llaves

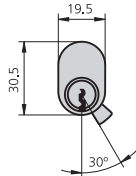

DESCRIPCIÓN	REF.	MEDIDAS			ACABADOS	APLICABLE A CERRADURAS	UDS	
		A	B	C				
<ul style="list-style-type: none"> <li>• Cilindro doble</li> </ul>	5979/3030/3	30	30	76	LP	1979	1	
	5979/3030/4	30	30	76	LN		1	
<ul style="list-style-type: none"> <li>• Cilindro doble con pomo</li> </ul>	5979P3030/3	30	30	76	LP	1979P	1	
	5979P3030/4	30	30	76	LN		1	

## VÍAS DE ESCAPE Y CORTAFUEGO

Barra Antipánico de Cierre Lateral con Marcado CE	145
• Serie 5000	145
Barra Antipánico acoplable a cerradura de embutir con Marcado CE	146
• Serie 5500	146
Barra Antipánico de cierre alto-bajo con Marcado CE	147
• Serie 6000	147
 Cerradura antipánico palanca deslizante entre ejes 85 mm	148
• Serie 615 <b>alupanic</b>	148
• Serie 615E <b>alupanic</b>	149
 Cerradura antipánico palanca deslizante entre ejes 92 mm	150
• Serie 612 <b>alupanic</b>	150
• Serie 612E <b>alupanic</b>	151
Cerradura con certificado EN12209	152
• Serie 400	152
Cerradura Cortafuego y Antipánico con Marcado CE	154
• Serie 410	154
Cerradura Antipánico	157
• Serie 3000	157
Cerraduras Electromagnéticas	159
Accesorios	160
• Escudos y Manillas de Acero Inoxidable	160
• Escudos y Manillas en Negro	161
• Cilindros y otros accesorios	162

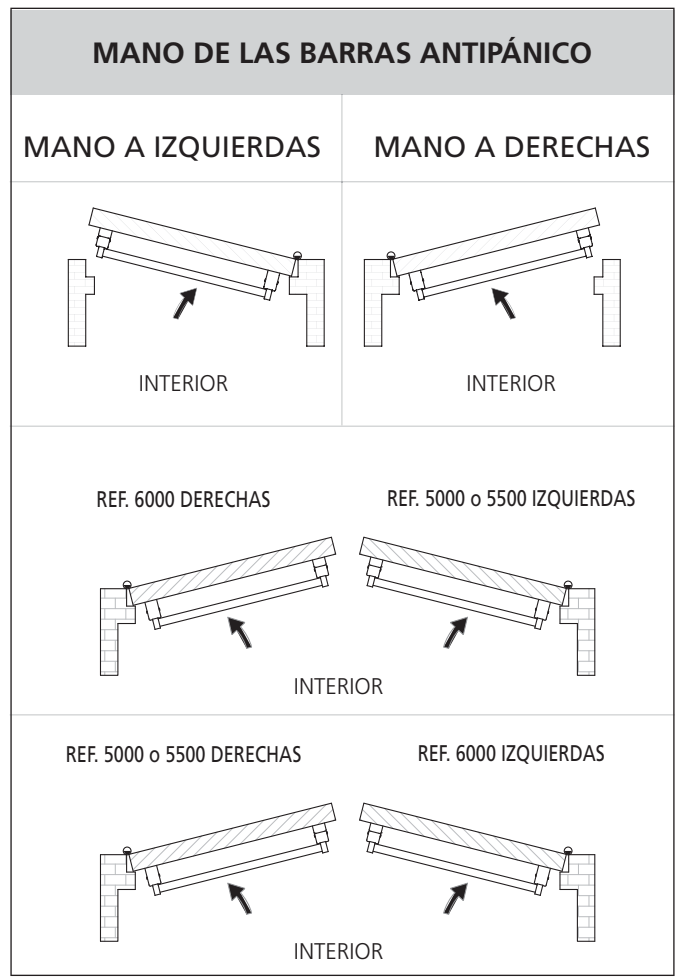
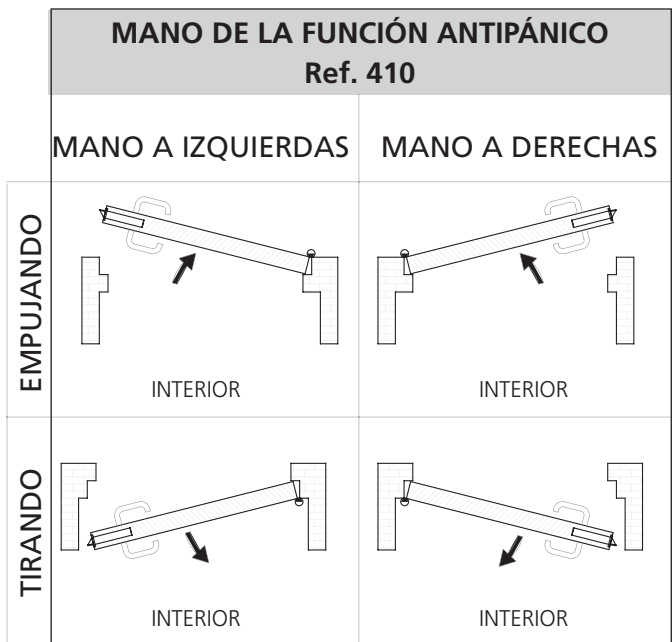



**BARRA ANTIPÁNICO DE CIERRE LATERAL CON MARCADO CE**

**SERIE 5000**

**CARACTERÍSTICAS**

- 1 punto de cierre lateral
- Solución reversible
- Cerradero CE5000
- Certificado según norma europea UNE-EN 1125

3 7 6 B 1 4 2 2 A B

**ACCESORIOS OPCIONALES**

- Barra de apoyo de medidas especiales
- Manilla y escudo en negro M5000, M5001, M5002, M5003
- Manilla y escudo de acero inoxidable CM5006, CM5007, CM5008, CM5009 para distintos entre ejes
- Cilindro B5000





ANTIPÁNICO INOX



ANTIPÁNICO NÍQUEL MATE

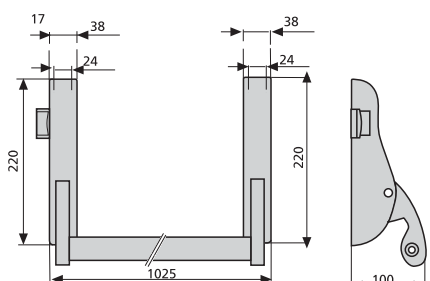

ANTIPÁNICO NEGRO

DESCRIPCIÓN	REF.	ACABADOS		UDS		
		SOPORTE	BARRA			
	5000/1N	Pintado negro	Pintado rojo	1	5	
	5000/1NM	Níquel mate	Acero inoxidable Aisi 304L	1	5	
	5000/6	Acero inoxidable Aisi 304L	Acero inoxidable Aisi 304L	1	5	



# BARRA ANTIPÁNICO ACOPLABLE A CERRADURA DE EMBUTIR CON MARCADO CE

# SERIE 5500



ANTIPÁNICO INOX



ANTIPÁNICO NÍQUEL MATE



ANTIPÁNICO NEGRO

## CARACTERÍSTICAS

- Acoplable a cerradura de embutir
- Solución reversible
- Certificado según norma europea UNE-EN 1125

3 7 6 B 1 4 2 2 A A

## ACCESORIOS OPCIONALES

- Cerradura antipánico serie 410LT y 410T, 3005
- Barra de apoyo de medidas especiales
- Manilla y escudo de acero inoxidable CM5006, CM5007, CM5008, CM5009 para distintos entre ejes
- Pomo y escudo en acero inoxidable CM5005 para distintos entre ejes



## DESCRIPCIÓN

## REF.

## ACABADOS

## UDS

### SOPORTE

### BARRA

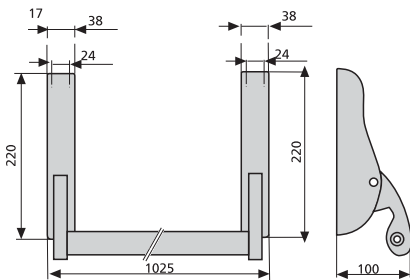

5500/1N	Pintado negro	Pintado rojo	1	5
5500/1NM	Níquel mate	Acero inoxidable Aisi 304L	1	5
5500/6	Acero inoxidable Aisi 304L	Acero inoxidable Aisi 304L	1	5

## FIRERATED LOCKS



3005 + manilla  
(ver página 159)



400T + tirador  
(ver página 155)



400T + tirador  
(ver página 155)



## BARRA ANTIPÁNICO DE CIERRE ALTO-BAJO CON MARCADO CE

## SERIE 6000

### CARACTERÍSTICAS

- 2 puntos de cierre alto-bajo
- Reversible sin accionamiento exterior
- Cerradores CER5000 y CEB6000
- Certificado según norma europea UNE-EN 1125

3 7 6 B 1 4 2 2 A A

### ACCESORIOS OPCIONALES

- Barra de apoyo y fallebas de medidas especiales
- Manilla y escudo en negro M5000, M5001, M5002, M5003
- Manilla y escudo de acero inoxidable CM5006, CM5007, CM5008, CM5009 para distintos entre ejes
- Cilindro B5000

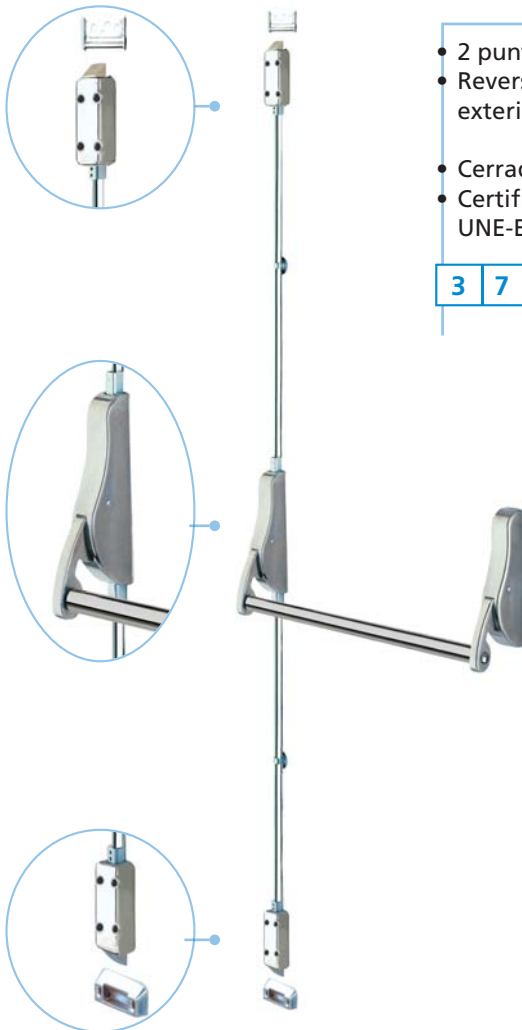

### DESCRIPCIÓN

### REF.

### ACABADOS

### UDS

#### SOPORTE

#### BARRA

#### FALLEBA

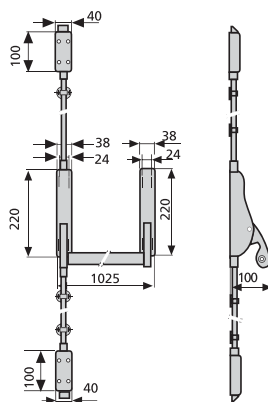

REF.	SOPORTE	BARRA	FALLEBA	UDS	UDS
6000D/1N	Pintado negro	Pintado rojo	Pintado negro	1	5
6000I/1N	Pintado negro	Pintado rojo	Pintado negro	1	5
6000D/1NM	Níquel mate	Acero inoxidable Aisi 304L	Acero inoxidable Aisi 304L	1	5
6000I/1NM	Níquel mate	Acero inoxidable Aisi 304L	Acero inoxidable Aisi 304L	1	5
6000D/6	Acero inoxidable Aisi 304L	Acero inoxidable Aisi 304L	Acero inoxidable Aisi 304L	1	5
6000I/6	Acero inoxidable Aisi 304L	Acero inoxidable Aisi 304L	Acero inoxidable Aisi 304L	1	5



**Novedad**



**CERRADURA ANTIPÁNICO PALANCA DESLIZANTE ENTRE EJES 85 mm**

**SERIE 615** **alupanic**



**CARACTERÍSTICAS**

- Cerradura antipánico para puertas de aluminio y metálicas
- Sistema antipánico reversible
- Frente inox. de 16, 22 o 24 mm
- Picaporte reversible de 11 mm
- Picaporte regulable, excepto en entrada de 25 mm
- Caja de 15 mm
- Cuadradillo de 8 mm
- Operado mediante llave y pomo o manilla desde el exterior
- Tornillo de fijación de cilindro

**ACCESORIOS OPCIONALES**

- Gama completa de cerraderos (ver páginas 42 - 48)
- Gama completa de cilindros (ver páginas 122 - 142)

DESCRIPCIÓN	REF.	MEDIDAS		LEVA	ACABADOS		UDS	
		B	A		FRENTE	CANTO		

- Picaporte y palanca
- Cilindro no incluido

- Opciones de cerradero (ver páginas 42 - 48)
- Opciones de cerradero eléctrico (ver página 49)

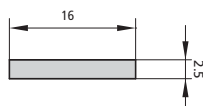
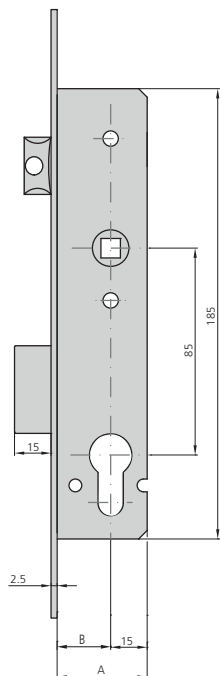

P615/25/6	22	37	15	Al	1	20
P615/30/6	27	42	15	Al	1	20
P615/35/6	32	47	15	Al	1	20

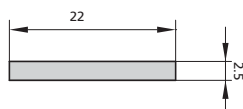

615/25/6	22	37	15	Al	1	20
615/30/6	27	42	15	Al	1	20
615/35/6	32	47	15	Al	1	20

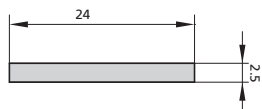

615/25/6AN	22	37	15	Al	1	20
615/30/6AN	27	42	15	Al	1	20
615/35/6AN	32	47	15	Al	1	20



**CARACTERÍSTICAS**

- Cerradura antipánico para puertas de aluminio y metálicas
- Sistema antipánico reversible
- Frente inox de 16, 22 o 24 mm
- Picaporte reversible de 11 mm
- Picaporte regulable, excepto en entrada de 25 mm
- Caja de 15 mm
- Cuadradillo de 8 mm
- Operado mediante llave y manilla desde el exterior. La llave bloquea o desbloquea la manilla
- Tornillo de fijación de cilindro

**ACCESORIOS OPCIONALES**

- Gama completa de cerraderos (ver páginas 42 - 48)
- Gama completa de cilindros (ver páginas 122 - 142)

DESCRIPCIÓN	REF.	MEDIDAS		LEVA	ACABADOS		UDS	
		B	A		FRENTE	CANTO		

- Picaporte y palanca
- Cilindro no incluido

- Opciones de cerradero (ver páginas 42 - 48)
- Opciones de cerradero eléctrico (ver página 49)

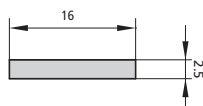
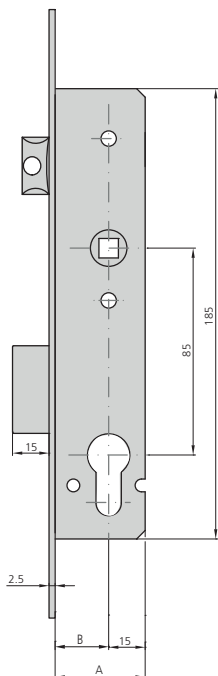

P615E/25/6	22	37	15	Al	1	20
P615E/30/6	27	42	15	Al	1	20
P615E/35/6	32	47	15	Al	1	20

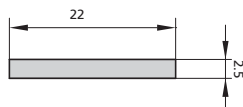

615E/25/6	22	37	15	Al	1	20
615E/30/6	27	42	15	Al	1	20
615E/35/6	32	47	15	Al	1	20

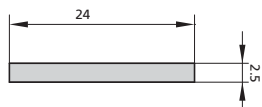

615E/25/6AN	22	37	15	Al	1	20
615E/30/6AN	27	42	15	Al	1	20
615E/35/6AN	32	47	15	Al	1	20

**Novedad**



**CERRADURA ANTIPÁNICO PALANCA DESLIZANTE ENTRE EJES 92 mm**

**SERIE 612** **alupanic**



**CARACTERÍSTICAS**

- Cerradura antipánico para puertas de aluminio y metálicas
- Sistema antipánico reversible
- Frente inox de 16, 22 o 24 mm
- Picaporte reversible de 11 mm
- Picaporte regulable, excepto en entrada de 25 mm
- Caja de 15 mm
- Cuadradillo de 8 mm
- Operado mediante llave y pomo o manilla desde el exterior
- Tornillo de fijación de cilindro

**ACCESORIOS OPCIONALES**

- Gama completa de cerraderos (ver páginas 42 - 48)
- Gama completa de cilindros (ver páginas 122 - 142)

**DESCRIPCIÓN**

**REF.**

**MEDIDAS**

**LEVA**

**ACABADOS**

**UDS**

**B A**

**FRENTE CANTO**



- Picaporte y palanca
- Cilindro no incluido
- Opciones de cerradero (ver páginas 42 - 48)
- Opciones de cerradero eléctrico (ver página 49)

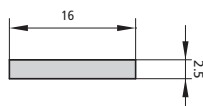

P612/25/6	22	37	15	Al	1	20
P612/30/6	27	42	15	Al	1	20
P612/35/6	32	47	15	Al	1	20

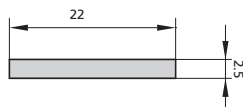

612/25/6	22	37	15	Al	1	20
612/30/6	27	42	15	Al	1	20
612/35/6	32	47	15	Al	1	20

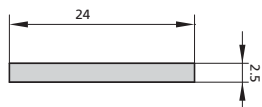

612/25/6AN	22	37	15	Al	1	20
612/30/6AN	27	42	15	Al	1	20
612/35/6AN	32	47	15	Al	1	20

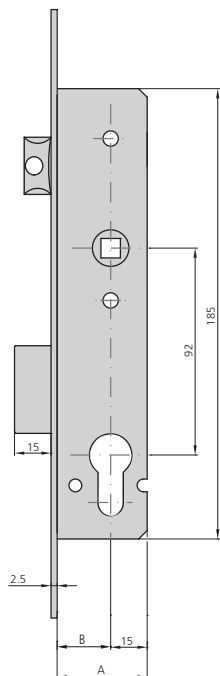

VÍAS DE ESCAPE Y CORTAFUEGO



**CARACTERÍSTICAS**

- Cerradura antipánico para puertas de aluminio y metálicas
- Sistema antipánico reversible
- Frente inox de 16, 22 o 24 mm
- Picaporte reversible de 11 mm
- Picaporte regulable, excepto en entrada de 25 mm
- Caja de 15 mm
- Cuadradillo de 8 mm
- Operado mediante llave y manilla desde el exterior. La llave bloquea o desbloquea la manilla
- Tornillo de fijación de cilindro

**ACCESORIOS OPCIONALES**

- Gama completa de cerraderos (ver páginas 42 - 48)
- Gama completa de cilindros (ver páginas 122 - 142)

DESCRIPCIÓN	REF.	MEDIDAS		LEVA	ACABADOS		UDS	
		B	A		FRENTE	CANTO		

- Picaporte y palanca
- Cilindro no incluido

- Opciones de cerradero (ver páginas 42 - 48)
- Opciones de cerradero eléctrico (ver página 49)

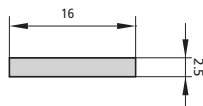
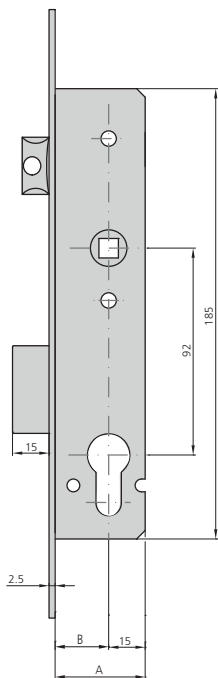

P612E/25/6	22	37	15	Al	1	20
P612E/30/6	27	42	15	Al	1	20
P612E/35/6	32	47	15	Al	1	20

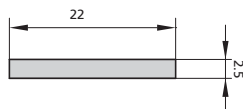

612E/25/6	22	37	15	Al	1	20
612E/30/6	27	42	15	Al	1	20
612E/35/6	32	47	15	Al	1	20

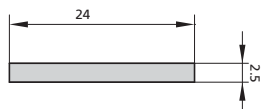

612E/25/6AN	22	37	15	Al	1	20
612E/30/6AN	27	42	15	Al	1	20
612E/35/6AN	32	47	15	Al	1	20



## CERRADURA CON CERTIFICADO EN12209

## SERIE 400

### CARACTERÍSTICAS

- Certificado según norma europea EN12209

**3 M 8 1 0 F 1 B C 2 0**

- Frente en acero inoxidable en canto redondo o cuadrado
- Caja niquelada
- Palanca de acero
- Cuadradillo de 8 mm
- Resbalón de hierro
- Tornillo de fijación de cilindro
- Cerradero de acero inoxidable en canto redondo ó cuadrado

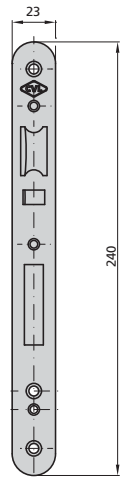

### ACCESORIOS OPCIONALES

- Gama completa de cilindros (ver páginas 122 - 142)



### DESCRIPCIÓN

### REF.

### MEDIDAS

B A

### LEVA

### ACABADOS

FRENTE CANTO

### UDS

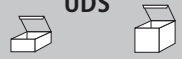

- Cerradura con picaporte y palanca rectangular de acero
- Cerradura con función antitarjeta

400L60/6HP	60	90	S. CIL	Al	Red	1	12
401L60/6HP	60	90	S. CIL	Al	Cua	1	12

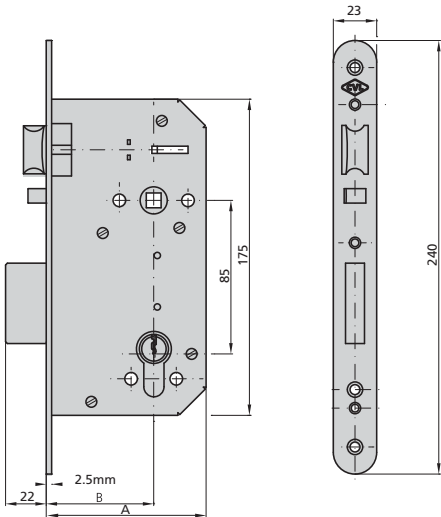

- Cerradura con picaporte y palanca rectangular de acero

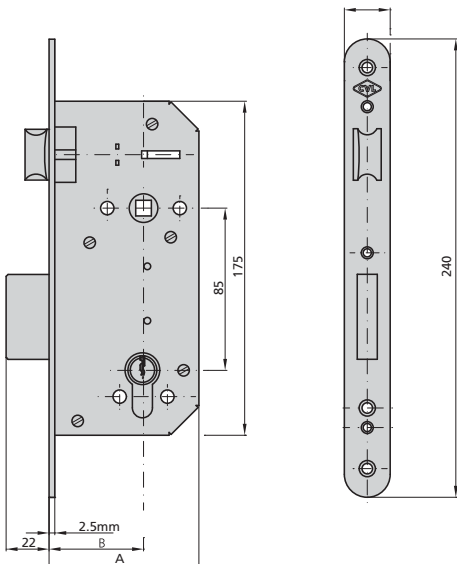

400/50/6HP	50	80	S. CIL	Al	Red	1	12
401/50/6HP	50	80	S. CIL	Al	Cua	1	12
400/60/6HP	60	90	S. CIL	Al	Red	1	12
401/60/6HP	60	90	S. CIL	Al	Cua	1	12





## CERRADURA CON CERTIFICADO EN12209

## SERIE 400

DESCRIPCIÓN	REF.	MEDIDAS		LEVA	ACABADOS		UDS	
		B	A		FRENTE	CANTO		
• Cerradura con sólo picaporte de acero	400LT60/6H	60	90	S. CIL	Al	Red	1	12
• Cerradura con función antitarjeta	401LT60/6H	60	90	S. CIL	Al	Cua	1	12

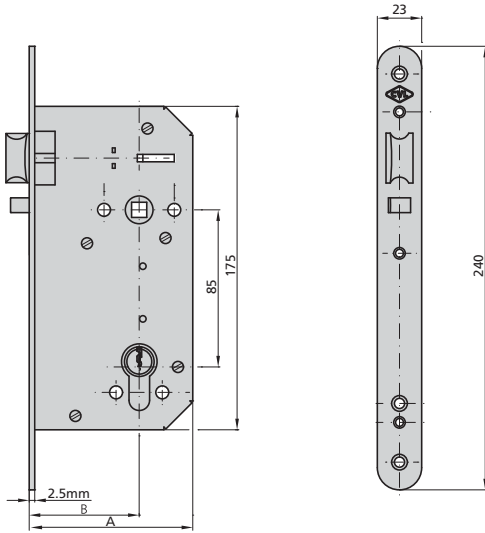

- Cerradura con solo picaporte de acero

400T50/6H	50	80	S. CIL	Al	Red	1	12
401T50/6H	50	80	S. CIL	Al	Cua	1	12
400T60/6H	60	90	S. CIL	Al	Red	1	12
401T60/6H	60	90	S. CIL	Al	Cua	1	12

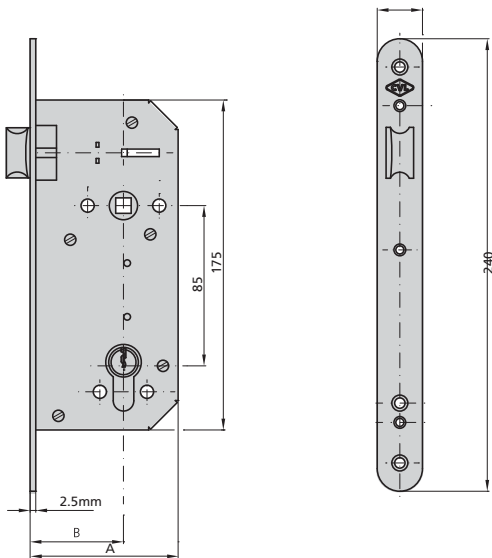



## CERRADURA CORTAFUEGO Y ANTIPÁNICO CON MARCADO CE

## SERIE 410



### CARACTERÍSTICAS

- Cerradura cortafuego con función antipánico
- Certificado según norma europea EN 12209

**3 M 8 1 0 F 1 B C 2 0**

- Certificado según norma europea EN179

**3 7 6 B 1 3 2 2 A B**

- Frente de acero inoxidable en canto redondo o cuadrado
- Caja niquelada
- Cuadradillo de 8 mm

- Cerraderos de acero inoxidable en canto redondo o cuadrado
- Tornillo de fijación de cilindro

### ACCESORIOS OPCIONALES

- Gama completa de cilindros (ver páginas 122 - 142)



### DESCRIPCIÓN

### REF.

### MEDIDAS

### LEVA

### ACABADOS

### UDS

B A

FRENTE CANTO



- Cerradura con picaporte y palanca rectangular de acero
- Cerradura con función antitarjeta
- Cerradura con función antipánico
- Cerradura con nueca partida

410L60D/6HP	60	90	S. CIL	Al	Red	1	12
410L60I/6HP	60	90	S. CIL	Al	Red	1	12
411L60D/6HP	60	90	S. CIL	Al	Cua	1	12
411L60I/6HP	60	90	S. CIL	Al	Cua	1	12

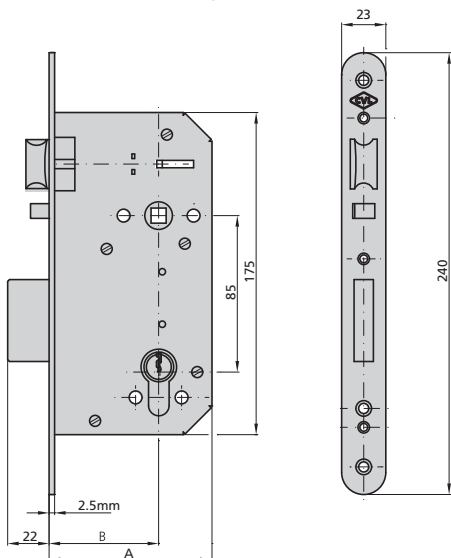



## CERRADURA CORTAFUEGO Y ANTIPÁNICO CON MARCADO CE

## SERIE 410

DESCRIPCIÓN	REF.	MEDIDAS		LEVA	ACABADOS		UDS	
		B	A		FRENTE	CANTO		
<ul style="list-style-type: none"> <li>• Cerradura con picaporte y palanca rectangular de acero</li> <li>• Cerradura con función antipánico</li> <li>• Cerradura con nueca partida</li> </ul>	410/50D/6HP	50	80	S. CIL	Al	Red	1	12
	410/50I/6HP	50	80	S. CIL	Al	Red	1	12
	411/50D/6HP	50	80	S. CIL	Al	Cua	1	12
	411/50I/6HP	50	80	S. CIL	Al	Cua	1	12
	410/60D/6HP	60	90	S. CIL	Al	Red	1	12
	410/60I/6HP	60	90	S. CIL	Al	Red	1	12
	411/60D/6HP	60	90	S. CIL	Al	Cua	1	12
	411/60I/6HP	60	90	S. CIL	Al	Cua	1	12

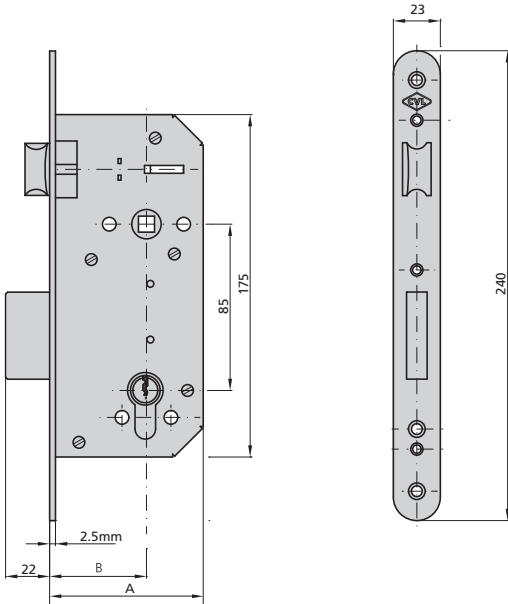

<ul style="list-style-type: none"> <li>• Cerradura con picaporte y palanca rectangular de acero</li> <li>• Cerradura con función antitarjeta</li> <li>• Cerradura con función antipánico</li> <li>• Cerradura con nueca pasante</li> </ul>	410L60/6HP	60	90	S. CIL	Al	Red	1	12
	411L60/6HP	60	90	S. CIL	Al	Cua	1	12

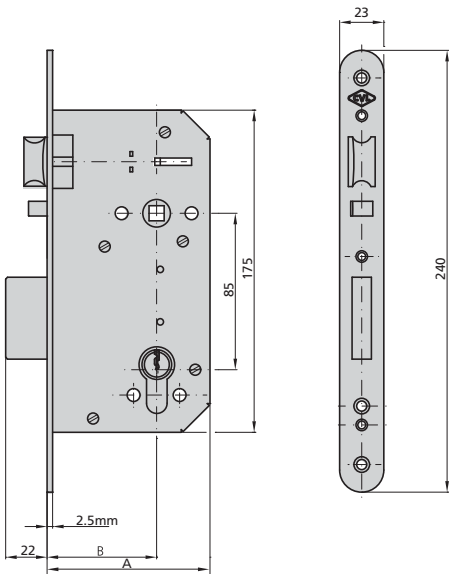







## CERRADURA CORTAFUEGO Y ANTIPÁNICO CON MARCADO CE

## SERIE 410

DESCRIPCIÓN	REF.	MEDIDAS		LEVA	ACABADOS		UDS	
		B	A		FRENTE	CANTO		
• Cerradura con picaporte y palanca rectangular de acero	410/50/6HP	50	80	S. CIL	Al	Red	1	12
	411/50/6HP	50	80	S. CIL	Al	Cua	1	12
• Cerradura con función antipánico	410/60/6HP	60	90	S. CIL	Al	Red	1	12
	411/60/6HP	60	90	S. CIL	Al	Cua	1	12

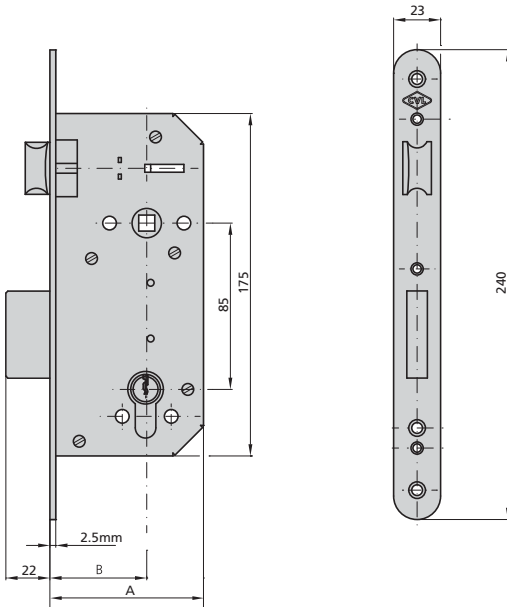



## CERRADURA ANTIPÁNICO

## SERIE 3000

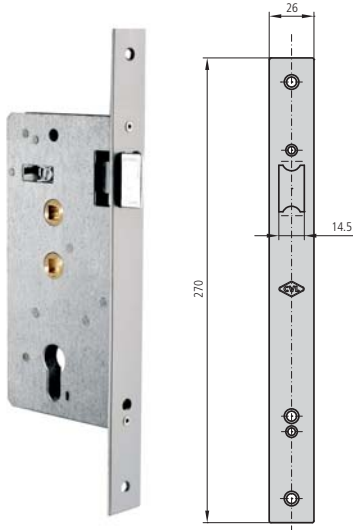



### CARACTERÍSTICAS

- Cerradura antipánico
- Frente en acero
- Cuadradillo de 8 mm
- Tornillo de fijación de cilindro
- Cerradero según cerradura
- Cilindro 5982/2535/3

### ACCESORIOS OPCIONALES

- Gama completa de cilindros (ver páginas 122 - 142)

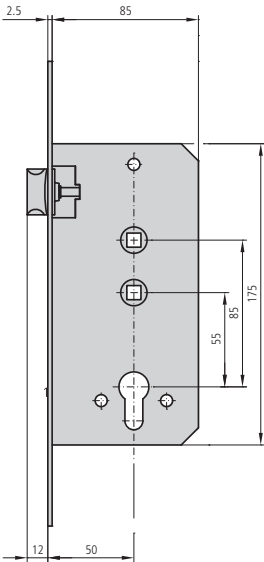

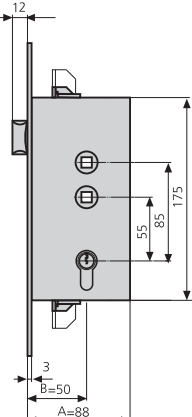
DESCRIPCIÓN	REF.	MEDIDAS		LEVA	ACABADOS		UDS	
		B	A		FRENTE	CANTO		
 <ul style="list-style-type: none"> <li>• Accionamiento exterior de manilla condensable mediante cilindro</li> <li>• Picaporte de acero reversible</li> </ul>	3005/6	50	88	15	Al	CL	1	12

 <ul style="list-style-type: none"> <li>• Accionamiento exterior de manilla condensable mediante cilindro</li> <li>• 3 puntos de cierre</li> </ul>	3000D	50	88	15	HE	CL	1	12
	3000I	50	88	15	HE	CL	1	12



## CERRADURA ANTIPÁNICO

## SERIE 3000

DESCRIPCIÓN	REF.	MEDIDAS		LEVA	ACABADOS		UDS	
		B	A		FRENTE	CANTO		

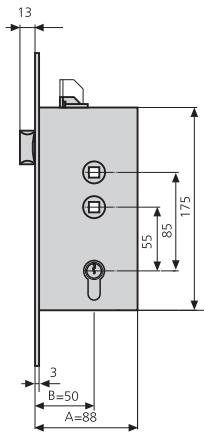

- Accionamiento exterior de manilla condensable mediante cilindro
- 2 puntos de cierre

3000AD	50	88	15	HE	CL	1	12
3000AI	50	88	15	HE	CL	1	12

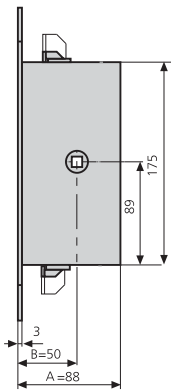

- Cerradura-cremona para hoja pasiva
- 2 puntos de cierre

3001	50	88		HE		1	12
------	----	----	--	----	--	---	----

## CERRADURAS ELECTROMAGNÉTICAS

DESCRIPCIÓN	REF.	FUERZA DE RETENCIÓN	UDS
<ul style="list-style-type: none"> <li>Cerradura electromagnética de empotrar</li> <li>Medidas electroimán 229x39x26</li> </ul>	VENM1	3000N	1
<ul style="list-style-type: none"> <li>Cerradura electromagnética de sobreponer</li> <li>Medidas electroimán 220x66x40</li> </ul>	VENM2	5000N	1
<ul style="list-style-type: none"> <li>Cerradura electromagnética de sobreponer</li> <li>Medidas electroimán 220x35x25</li> </ul>	VENM3	3000N	1
<ul style="list-style-type: none"> <li>Cerradura electromagnética de empotrar para puertas de vaivén</li> <li>Medidas electroimán 165x31x26</li> </ul>	VENM54	7500N	1

## ACCESORIOS

# ESCUDOS Y MANILLAS DE ACERO INOXIDABLE



### CARACTERÍSTICAS

- Manillas de acero inoxidable certificadas en procedimientos de ensayo de la norma EN 179

DESCRIPCIÓN	REF.	ACABADO	CANTO	UDS
<ul style="list-style-type: none"> <li>• Escudo con manilla y bocallave cilindro</li> <li>• Entre ejes 55 mm</li> <li>• Cilindro no incluido</li> </ul>	CM5006/55/6R	Al	Red	1
<ul style="list-style-type: none"> <li>• Escudo con manilla y bocallave cilindro</li> <li>• Entre ejes 72 mm</li> <li>• Cilindro no incluido</li> </ul>	CM5006/72/6R	Al	Red	1
<ul style="list-style-type: none"> <li>• Escudo con manilla y bocallave cilindro</li> <li>• Entre ejes 85 mm</li> <li>• Cilindro no incluido</li> </ul>	CM5006/85/6R	Al	Red	1
<ul style="list-style-type: none"> <li>• Escudo con manilla</li> </ul>	CM5007/6R	Al	Red	1

**ACCESORIOS**
**ESCUDOS Y MANILLAS EN NEGRO**

**CARACTERÍSTICAS**

- Manillas pintadas en negro

DESCRIPCIÓN	REF.	ACABADO	CANTO	UDS
<ul style="list-style-type: none"> <li>• Escudo con manilla y bocallave cilindro</li> <li>• Entre ejes 55 mm</li> <li>• Incluye cilindro B5000</li> </ul>	M5000/1N	Negro	Cua	1
<ul style="list-style-type: none"> <li>• Escudo con manilla</li> </ul>	M5001/1N	Negro	Cua	1
<ul style="list-style-type: none"> <li>• Escudo con bocallave cilindro</li> <li>• Entre ejes 55 mm</li> <li>• Incluye cilindro B5000</li> </ul>	M5002/1N	Negro	Cua	1
<ul style="list-style-type: none"> <li>• Escudo ciego</li> </ul>	M5003/1N	Negro	Cua	1
<ul style="list-style-type: none"> <li>• Escudo con tirador y bocallave</li> <li>• Incluye cilindro B5000</li> </ul>	M5004/1N	Negro	Cua	1

**ACCESORIOS**
**CILINDROS Y OTROS ACCESORIOS**

DESCRIPCIÓN	REF.	ACABADO	UDS
• Cilindro para barra antipánico	B5000	CL	1
	B5000/4	CN	1

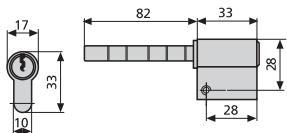

DESCRIPCIÓN	REF.	ACABADO
• Barra de apoyo Ø25*1000 mm	BAR5000/6	Al
• Barra de apoyo Ø25*1500 mm	BAR5000/6E	Al
• Barra de apoyo Ø25*1000 mm	BAR5000/1R	HE rojo
• Barra de apoyo Ø25*1500 mm	BAR5000/1RE	HE rojo
• Tubo falleba Ø12*1000 mm	TUF6000/6	Al
• Tubo falleba Ø12*1500 mm	TUF6000/6E	Al
• Tubo falleba Ø12*1000 mm	TUF6000/1N	HE negro
• Tubo falleba Ø12*1500	TUF6000/1NE	HE negro
• Cerradero lateral	CE5000/1N	HE negro
• Cerradero lateral	CE5000/6	Al
• Cerradero bajo	CEB6000/1N	Acero microfundido negro
• Cerradero bajo	CEB6000	Acero microfundido

## CONTROL DE ACCESOS

	<b>Palanca deslizante entre ejes 85 mm</b>	<b>164</b>
	• Serie ID1 <b>inDeco</b>	164
	<b>Kit lector de proximidad MIFARE</b>	<b>165</b>
	• Control de acceso autónomo	165
	<b>Escudo electrónico de proximidad</b>	<b>166</b>
	• Control de acceso autónomo	166



**Novedad**

**PALANCA DESLIZANTE ENTRE EJES 85 mm.**

**SERIE ID1 inDeco**

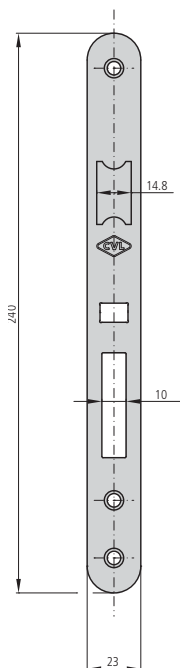

**CARACTERÍSTICAS**

- Cerradura de 1 punto de cierre con frente inox de 23 mm en canto redondo
- Picaporte reversible de acero
- Incluye función antitarjeta
- Palanca de acero de 21 mm de salida
- Cierre automático de la palanca al cerrar la puerta
- Inteligencia invisible: sistema electromecánico integrado en la cerradura habilitando la manilla exterior mediante un accionamiento eléctrico
- Función antipánico desde el interior
- Función antipánico reversible
- Cerradura preparada para atado normalizado de manillas y rosetas
- Incluye CPU con batería
- Incluye cerradero CEID1/6D y CEID1/6I
- Tornillo de fijación de cilindro
- Componentes de sujeción

**ACCESORIOS OPCIONALES**

- Gama completa de cilindros (ver páginas 122 - 142)
- Lector de proximidad

DESCRIPCIÓN	REF.	MEDIDAS		LEVA	ACABADOS		UDS	
		B	A		FRENTE	CILINDRO		
<ul style="list-style-type: none"> <li>• Picaporte y palanca</li> <li>• Cilindro no incluido</li> </ul>	ID1/60/6	90	60	15	Al		1	

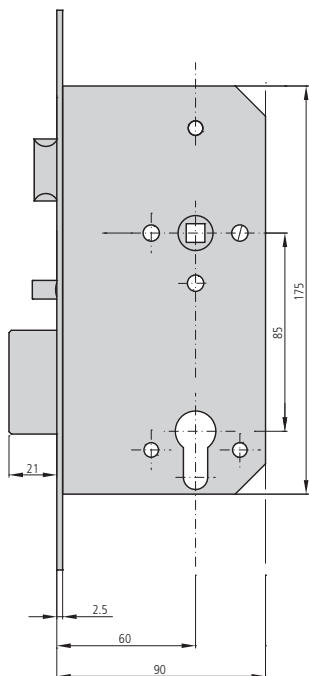

**KIT LECTOR DE PROXIMIDAD MIFARE**

**CONTROL DE ACCESO AUTÓNOMO**

**CARACTERÍSTICAS**

- Kit control de acceso
- Apertura con tarjeta de proximidad
- Listo para utilizar:
  - Tarjetas y lector configurados desde fábrica
  - Sin necesidad de software
- Posibilidades amplias de amaestramiento
- Tecnología Network on Card
- Conectable a cerradura eléctrica DUE, o cerraderos eléctricos
- CPU HS/C
- Tarjetas Mifare configuradas

**ACCESORIOS OPCIONALES**



**DESCRIPCIÓN**

**REF.**

**MEDIDAS**  
B A

**LEVA**

**ACABADOS**  
FRENTE CILINDRO

**UDS**



- Lector de proximidad R/W i/BUTTON

14154000

1

- CPU HS/C NOC

14154000

1



- Tarjeta MIFARE 1K numerada

13718000

1



**Novedad**

**ESCUDO ELECTRÓNICO DE PROXIMIDAD**

**CONTROL DE ACCESO AUTÓNOMO**





**CARACTERÍSTICAS**

- Sistema de control de acceso autónomo con lector integrado
- Apertura con tarjeta de proximidad
- Listo para utilizar:
  - Tarjetas y lector configurados desde fábrica
  - Sin necesidad de software
  - Sin necesidad de cableado (alimentación por pilas)
- Posibilidades amplias de amaestramiento
- Tecnología Network on Card
- Escudo inox de anchura de 30 mm adaptable a carpintería de aluminio
- Tarjetas Mifare configuradas

**ACCESORIOS OPCIONALES**

- Cerradura 410 o 410L

DESCRIPCIÓN	REF.	MEDIDAS B A	LEVA	ACABADOS FRENTE CILINDRO	UDS
<ul style="list-style-type: none"> <li>• Escudo electrónico de proximidad</li> </ul> 	1404X000-Y				1
<ul style="list-style-type: none"> <li>• Tarjeta MIFARE 1K numerada</li> </ul> 	13718000				1

## VARIOS

Otros	168
• Seguridad	168

## LLAVE SERRETA

### DESCRIPCIÓN

Cilindro largo especial  
Maestramiento. 1 lado  
Maestramiento. 2 lados  
Gran Maestra. Un lado  
Gran Maestra. Dos lados  
Cilindro con llaves iguales  
Cilindro con llaves según muestra

Llave suplementaria (125)  
Llave sin mecanizar (125)  
Llave mecanizada según muestra (125)  
Llave gorja suplementaria (63R)  
Llave gorja (63R)

Reductor metálico

Rgo. alargamiento de cilindro (60, 70, 80 mm) cerradura sobreponer

Rgo. configuración tarjeta Mifare

Rgo. frente 2300 mm

Rgo. frente 1500 mm

## SEGURIDAD

### DESCRIPCIÓN

Maestramiento. 1 lado  
Maestramiento. 2 lados  
Llave suplementaria  
Llave sin mecanizar  
Llave mecanizada según muestra  
Cilindro con llaves iguales  
Cilindro con llaves según muestra





Sistemas Valle Léniz S.L.U. • Pol. Arbi Zelai • Apdo 6, 20550 • Aretxabaleta • Gipuzkoa (Spain)  
Tel: 943 79 10 16 • Fax: 943 79 25 46 • E-mail: cvl@cvl.es • Web: www.cvl.es